



**It's not magic, it's engineering.®**

Impact and Airborne Sound Control

# GENIEMAT<sup>®</sup> FIT

For Weight Drop Impact Insulation

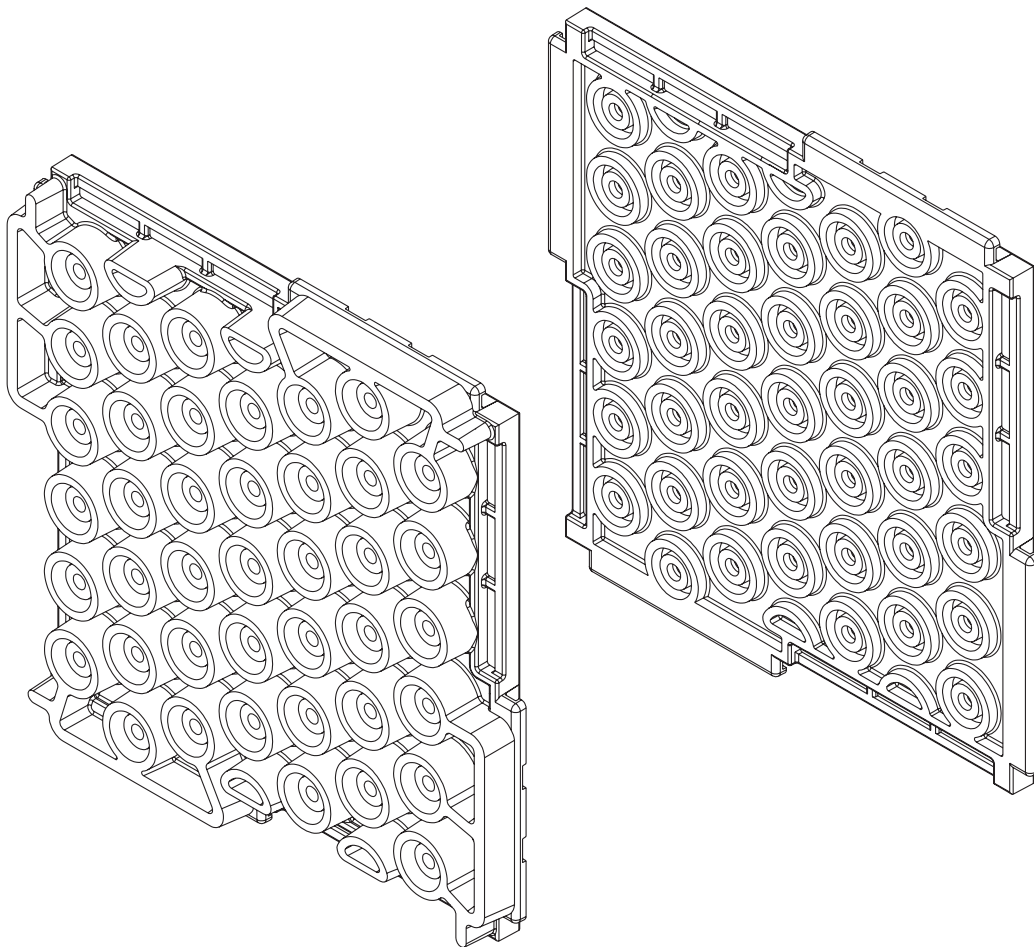

UK EDITION

Patent Pending

# GENIEMAT<sup>®</sup> FIT

## All-in-one fitness flooring

### PRODUCT FEATURES

**GenieMat FIT** is an all-in-one fitness floor made from recycled rubber, engineered to reduce structure-borne sound and vibration transmission in concrete, wood frame and metal deck construction.

**GenieMat FIT** floors dramatically reduce low frequency impact noise in free weight areas, under cardio equipment and in fitness studios.

	<b>GenieMat FIT08</b>		<b>GenieMat FIT30</b>	<b>GenieMat FIT70</b>
Weight per tile/roll	77 kg/roll		9.4 kg/tile	16.7 kg/tile
Thickness	8 mm		30 mm	70 mm
Installed Dimension	1220 mm x 7620 mm	587 mm x 587 mm	607 mm x 607 mm	607 mm x 607 mm
Product Type	Roll	Puzzle	Interlocking Tile	Interlocking Tile

All listed dimensions are nominal.

**GenieMat FIT30** and **GenieMat FIT70** have a product and installed dimension tolerance of +/- 3 mm.

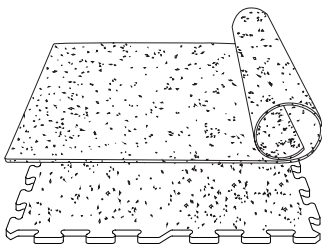

## GenieMat® FIT08

### APPLICATIONS

- Entryways/corridors
- Group fitness areas
- Locker rooms
- Spinning studios

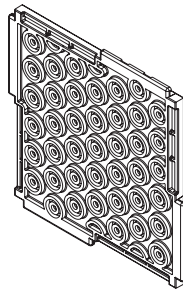

## GenieMat FIT30

### APPLICATIONS

- Cardio studios
- Personal training areas
- Machine areas

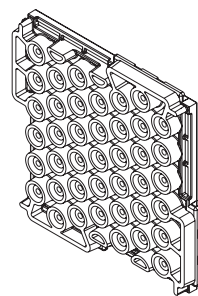

## GenieMat FIT70

### APPLICATIONS

- High impact studios
- Free weight/dumbbell areas

# ENGINEERED FOR PERFORMANCE

## GenieMat® FIT DESIGN CRITERIA

### SIGNIFICANTLY REDUCES STRUCTURE-BORNE VIBRATION

- Low dynamic stiffness for improved low frequency response
- Engineered dual cylinder pedestals reduce vibration transmission
- Decreased impact force exposure level as measured using heavy/hard impact sources

### SEAMLESS, INTERLOCKING FIT

- Tiles are installed in compression to have a seamless aesthetic and eliminate seam separation over time
- Seam compression of 10.3 N/mm (59 lbf/in)

### DESIGN OBJECTIVES OF A LOCALLY REACTIVE TILE

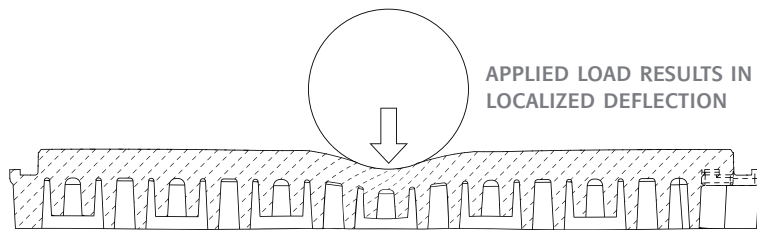

TIME DOMAIN FORCE PULSE

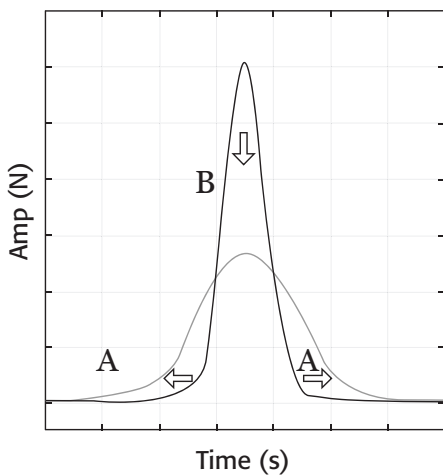

- A. Extending contact time improves lower frequency attenuation
- B. Reducing peak force value reduces overall sound pressure level

FREQUENCY DOMAIN FORCE PULSE

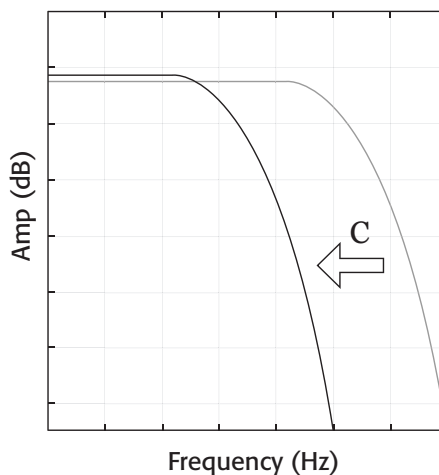

- C. Reducing 3 dB down point frequency improves lower frequency attenuation

DURABILITY

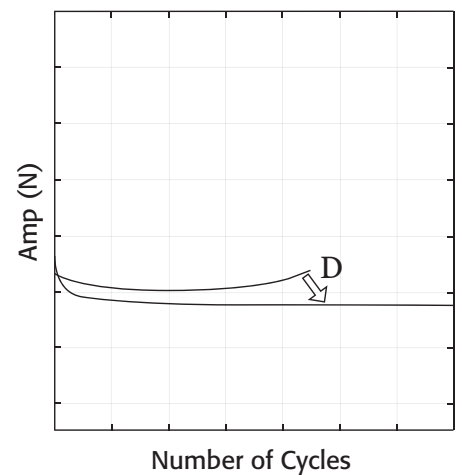

- D. Flattening out durability curve equates to improved product lifetime
- Plot of peak force values taken from repeated force pulse measurements



## FORCE PULSE MEASUREMENTS OF GENIEMAT® FIT SYSTEMS

- Can be used to predict in-situ performance. Contact **Pliteq** for *Internoise 2018* paper and methodology

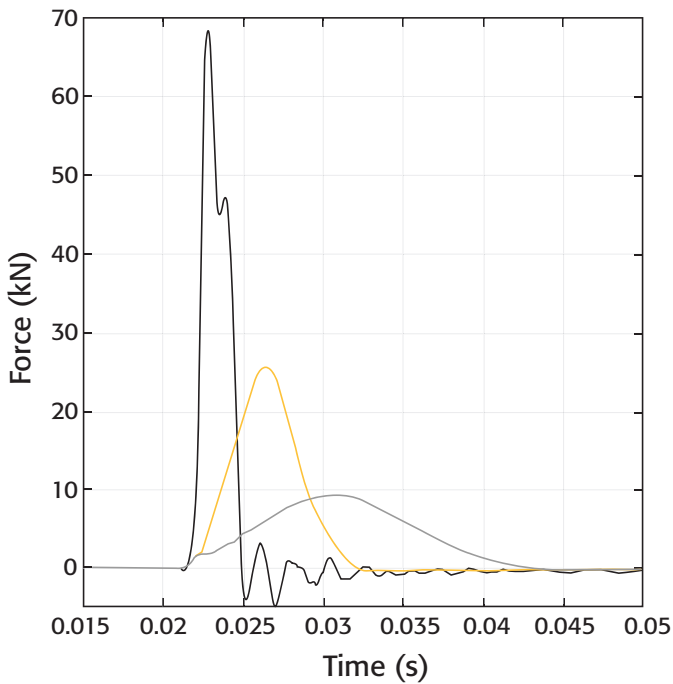

**GenieMat FIT08**  
 **GenieMat FIT30**  
 **GenieMat FIT70**

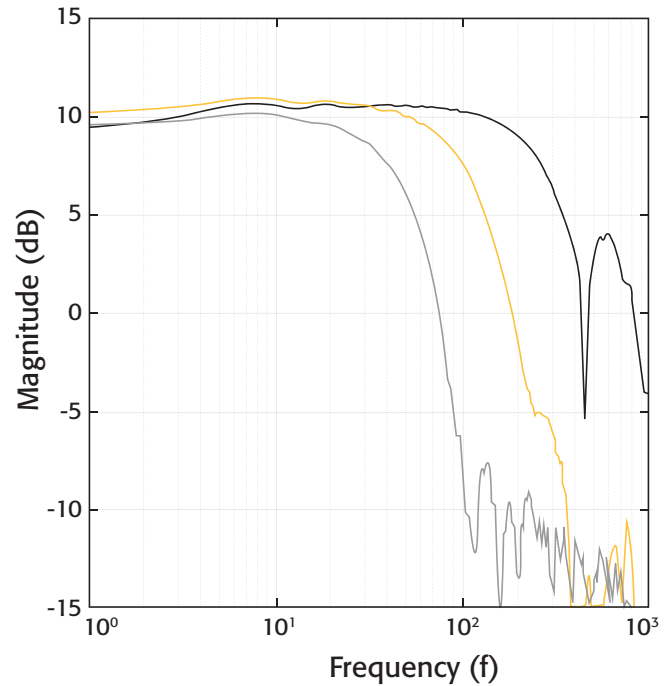

**GenieMat FIT08**  
 **GenieMat FIT30**  
 **GenieMat FIT70**

## ENGINEERING DESIGN CHARACTERISTICS

TEST RESULTS				
TEST DESCRIPTION	STANDARD REFERENCE	<b>GenieMat® FIT08</b>	<b>GenieMat® FIT30</b>	<b>GenieMat® FIT70</b>
Slip Resistance	ASTM D2047	0.90	0.81	0.81
Tensile Strength	ASTM D412	1.72 N/mm <sup>2</sup>	0.74 N/mm <sup>2</sup>	0.63 N/mm <sup>2</sup>
CHPS Section 01350	ASTM D5116	Pass	Pass	Pass
Chemical Resistance	ASTM F925	No Change	No Change	No Change
Impact Force Exposure Level	ISO 10140 - Part 5	43 dB	41 dB	39 dB
Critical Radiant Flux	ASTM E648	Class I /Class II*	Class I /Class II*	Class I /Class II*

\*Class I available upon request.

# GENIEMAT® xFIT

## GenieMat xFIT TESTING

US Patent: US 10,676,920 B2

### FORCE PULSE

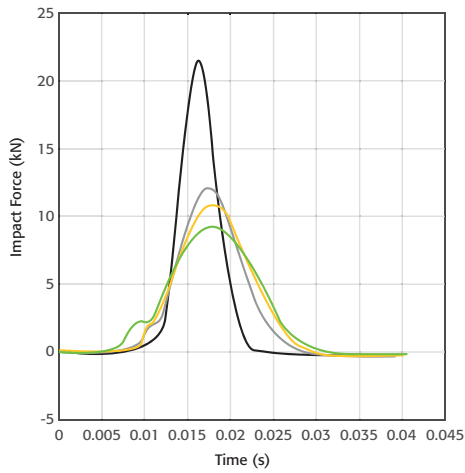

- GenieMat FIT30
- GenieMat FIT70
- GenieMat xFIT70
- GenieMat xFIT100

### FATIGUE TESTING

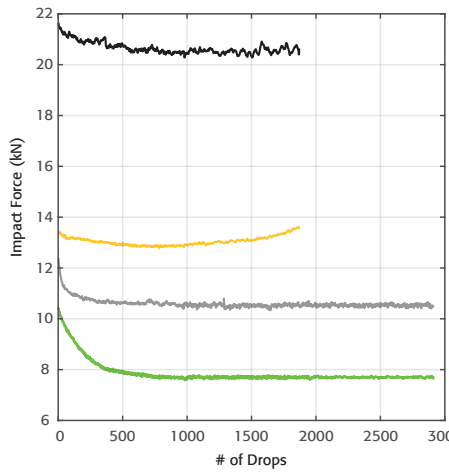

- GenieMat FIT30
- GenieMat FIT70
- GenieMat xFIT70
- GenieMat xFIT100

### REBOUND PLOTS

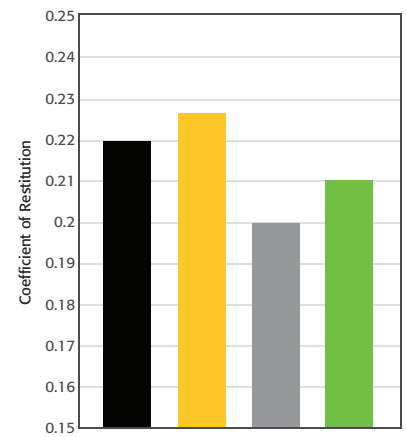

- GenieMat FIT30
- GenieMat FIT70
- GenieMat xFIT70
- GenieMat xFIT100

### ENGINEERING DESIGN CHARACTERISTICS

	GenieMat xFIT70	GenieMat xFIT100
Weight/sf	4.2 kg/sf	5.3 kg/sf
Thickness	70 mm	100 mm
Product Finish	Interlocking Tile	Interlocking Tile

### PLATFORMS

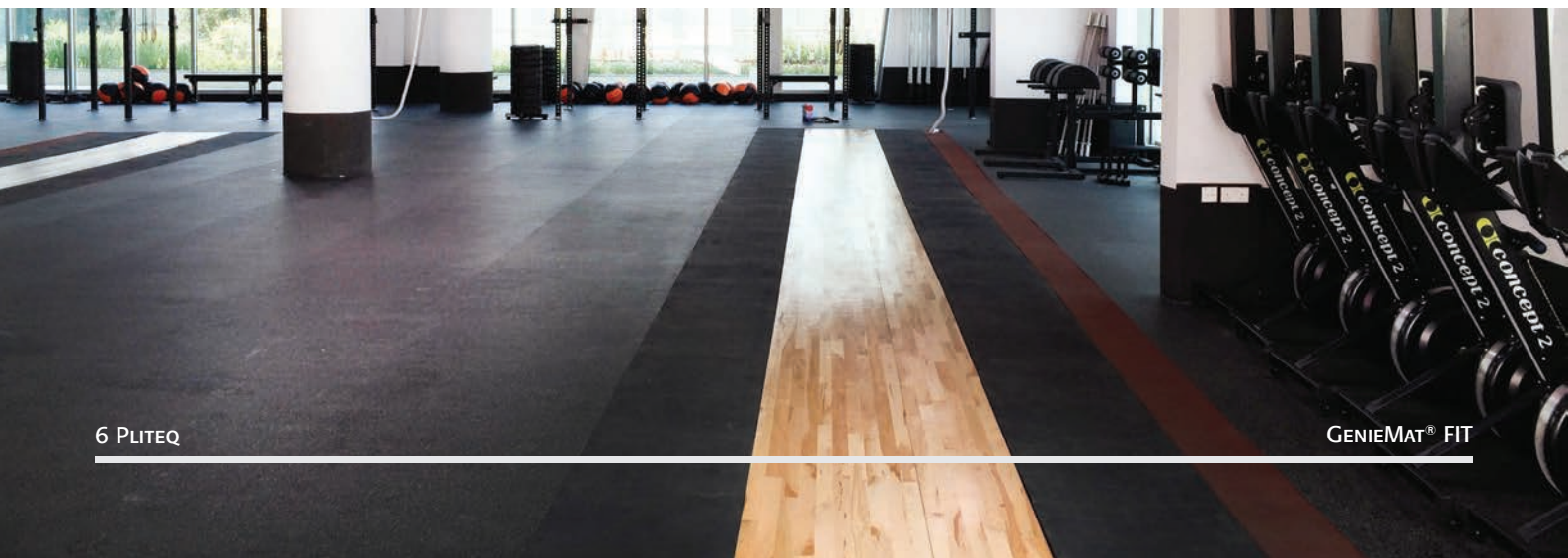

# HYBRID SYSTEM

WITH **GenieMat® FIT** AND **GenieMat FF**

## LOCALLY REACTIVE

APPLIED LOAD RESULTS IN LOCALIZED DEFLECTION

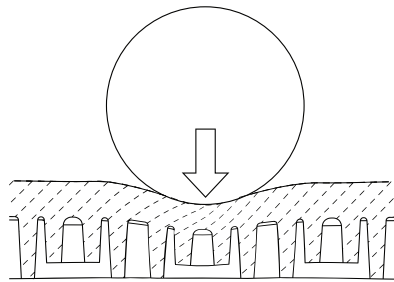

RESILIENT TILE

## RESONANTLY REACTIVE

APPLIED LOAD RESULTS IN DISTRIBUTED DEFLECTION

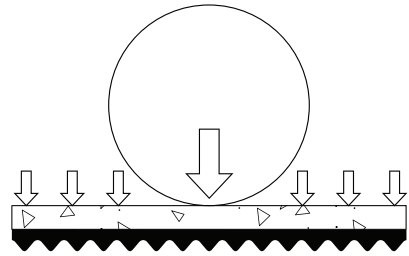

RIGID LAYER & RESILIENT UNDERLAYMENT

LOCALLY REACTIVE ABOVE RESONANTLY REACTIVE CREATES A HYBRID SYSTEM

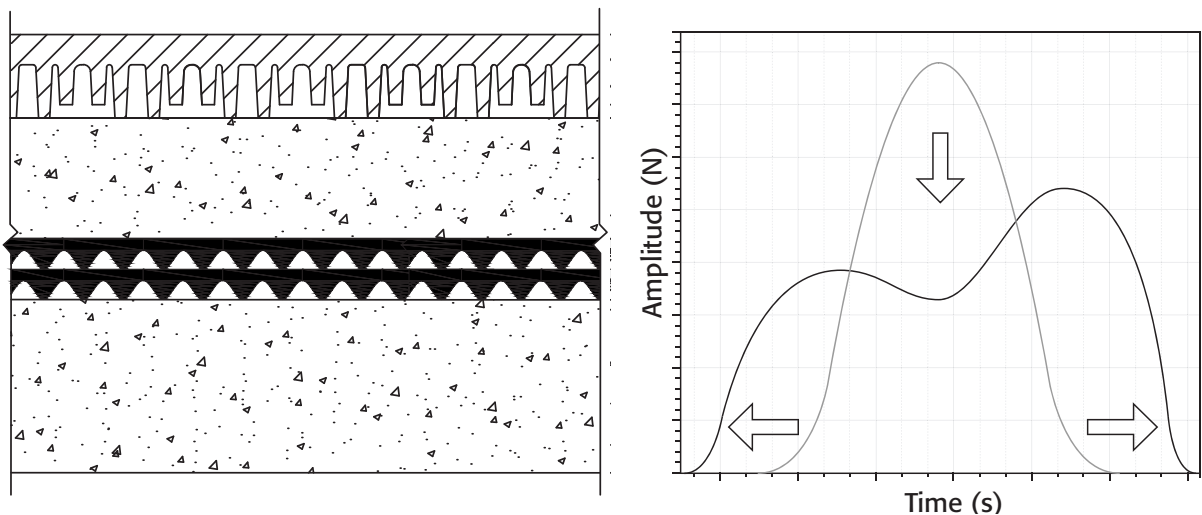

- Helps reduce impact force amplitude and increase force impulse duration
- Ideal for rhythmic excitation such as dance studios and treadmill bays

# TILE DATA

**Heavy Weight Drop - Acceleration  
39" (1.0 m) 15 lb (6.8 kg)**

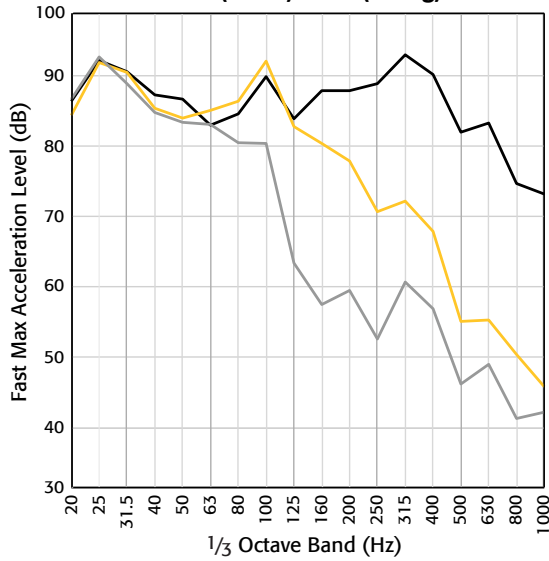

- E5600.12 **GenieMat FIT08**
- E5600.14 **GenieMat FIT30**
- E5600.15 **GenieMat FIT70**

**Heavy Weight Drop - Acceleration  
39" (1.0 m) 100 lb (45.4 kg)**

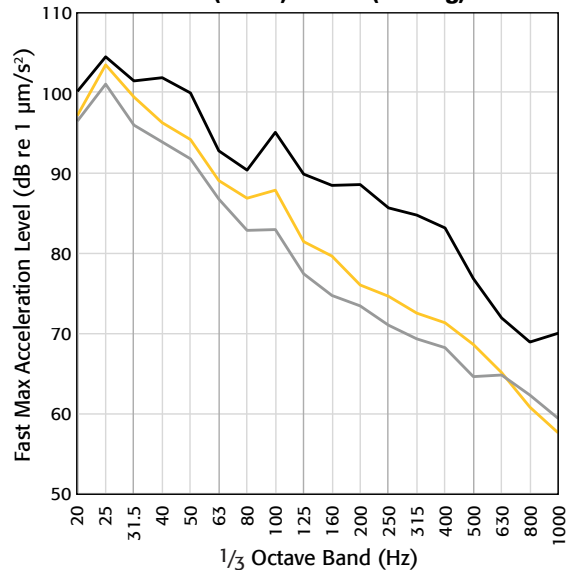

- E5600.15 **GenieMat FIT70**
- E5600.16 **GenieMat xFIT70**
- E5600.17 **GenieMat xFIT100**

# PLYWOOD HYBRID

**Heavy Weight Drop - Acceleration  
39" (1.0 m) 15 lb (6.8 kg)**

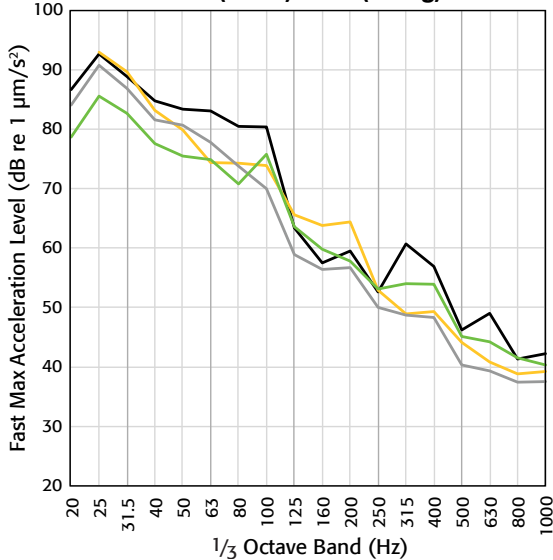

- E5600.15 **GenieMat FIT70**
- E5600.26 **GenieMat FIT70, 13 mm Cement Board, GenieMat FF25**
- E5600.29 **GenieMat FIT70, 19 mm Plywood, GenieMat FF70**
- E5600.31 **GenieMat FIT70, 19 mm Plywood, GenieMat FF70LDM**

**Heavy Weight Drop - Acceleration  
39" (1.0 m) 100 lb (45.4 kg)**

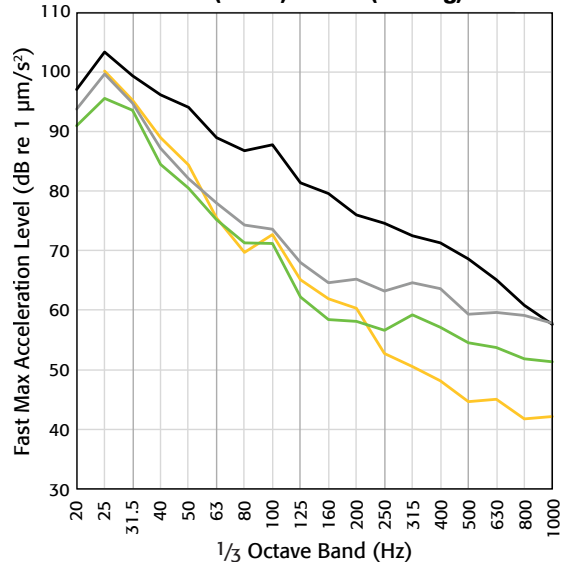

- E5600.16 **GenieMat xFIT70**
- E5600.27 **GenieMat xFIT70, 13 mm Cement Board, GenieMat FF25**
- E5600.30 **GenieMat xFIT70, 19 mm Plywood, GenieMat FF70**
- E5600.32 **GenieMat xFIT70, 19 mm Plywood, GenieMat FF70LDM**



# CONCRETE HYBRID

NOTE: FCS - Floating Concrete Slab

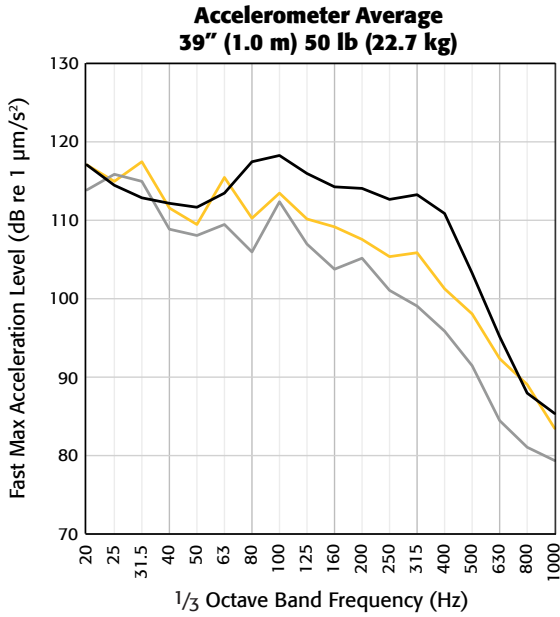

- A1-008867-01F **GenieMat FIT08**, 102 mm FCS, **GenieMat FF50**
- A1-008867-04F **GenieMat FIT08**, 102 mm FCS, **GenieMat FF70**
- A1-008867-05F **GenieMat FIT08**, 102 mm FCS, **GenieMat FF70LDM**

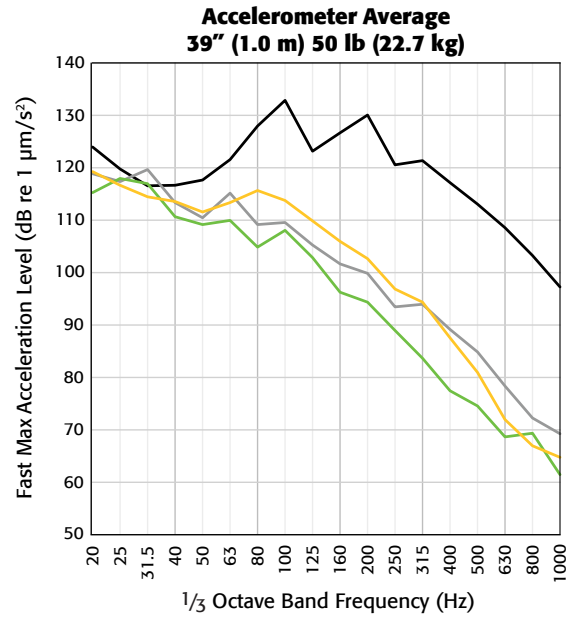

- A1-008867-00F **GenieMat FIT30**
- A1-008867-01F **GenieMat FIT30**, 102 mm FCS, **GenieMat FF50**
- A1-008867-04F **GenieMat FIT30**, 102 mm FCS, **GenieMat FF70**
- A1-008867-05F **GenieMat FIT30**, 102 mm FCS, **GenieMat FF70LDM**

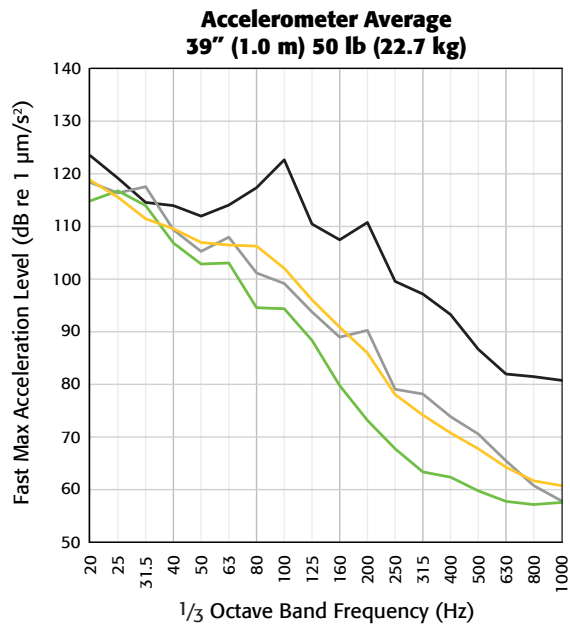

- A1-008867-00F **GenieMat FIT70**
- A1-008867-01F **GenieMat FIT70**, 102 mm FCS, **GenieMat FF50**
- A1-008867-04F **GenieMat FIT70**, 102 mm FCS, **GenieMat FF70**
- A1-008867-05F **GenieMat FIT70**, 102 mm FCS, **GenieMat FF70LDM**

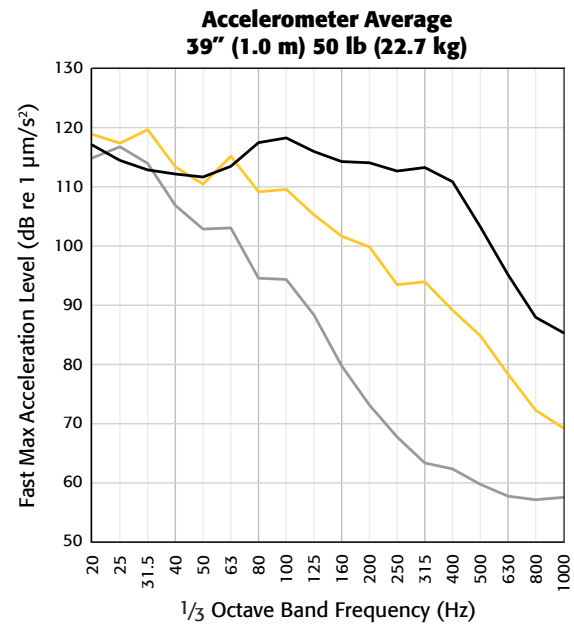

- A1-008867-01F **GenieMat FIT08**, 102 mm FCS, **GenieMat FF50**
- A1-008867-04F **GenieMat FIT30**, 102 mm FCS, **GenieMat FF70**
- A1-008867-05F **GenieMat FIT70**, 102 mm FCS, **GenieMat FF70LDM**

# GENIEMAT<sup>®</sup> TMIP

## TREADMILL ISOLATION PADS

U.S Patent No.: 8,113,495  
 Canadian Patent No.: 2,505,938

**GenieMat TMIP** are inherently non-slip. Custom sizes are available for other special applications.

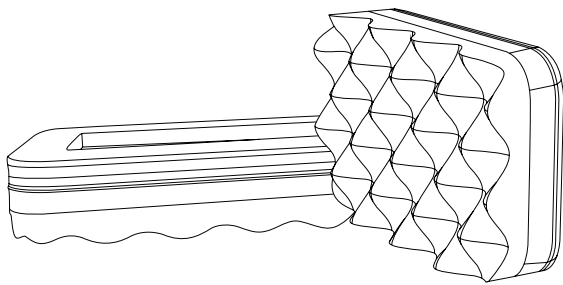

STANDARD THICKNESS	51 mm
STANDARD SIZES	127 mm x 457 mm – Front Mounts 127 mm x 178 mm – Rear Mounts
STATIC DEFLECTION	Lightweight case: 45 kg user (10.1 kPa load deflection): 1 to 2 cm Heavyweight case: 136 kg user (19.0 kPa load deflection): 2 to 3 cm

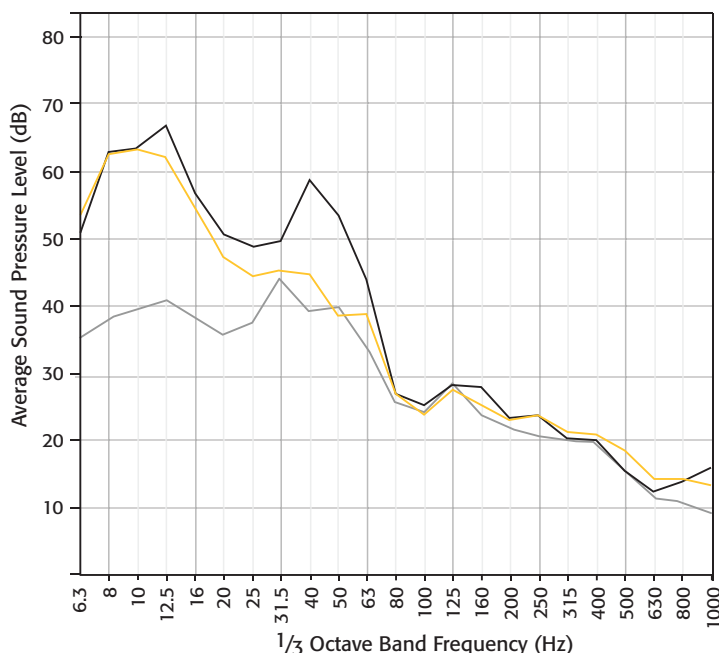

### ENGINEERED TO REDUCE LOW FREQUENCY IMPACT

Field Measured Average Sound Pressure Levels

- Running with 1 layer of 18 mm rubber
- Running with **GenieMat<sup>®</sup> TMIP** on 1 layer of 18 mm rubber
- Ambient sound level, no running

# GENIEMAT<sup>®</sup> WSI

## WEIGHT STACK ISOLATORS

Patent pending

GenieMat WSI isolates impact noise from selectorized machines.

- Reduce impact noise at the source
- Customized size to fit every weight stack
- Installation does not require machine disassembly

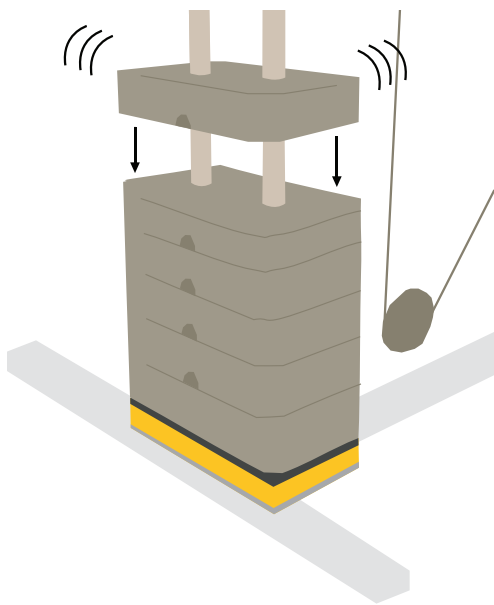

**Force Pulse Comparison**  
20" (0.5 m) 50 lb (22.7 kg)

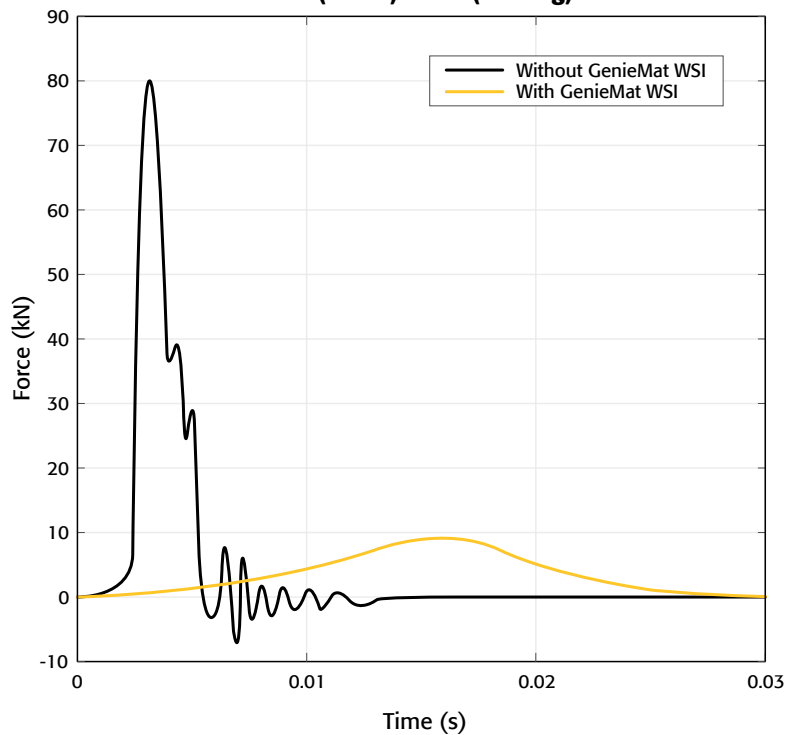

## GENIEMAT<sup>®</sup> FIT ACCESSORIES

- Customized on site to accommodate any threshold
- Accessories for all installation types
- Corner transitions created in the field
- **GenieMat FASHM** adhesive
- Load plates available to accommodate high point loads

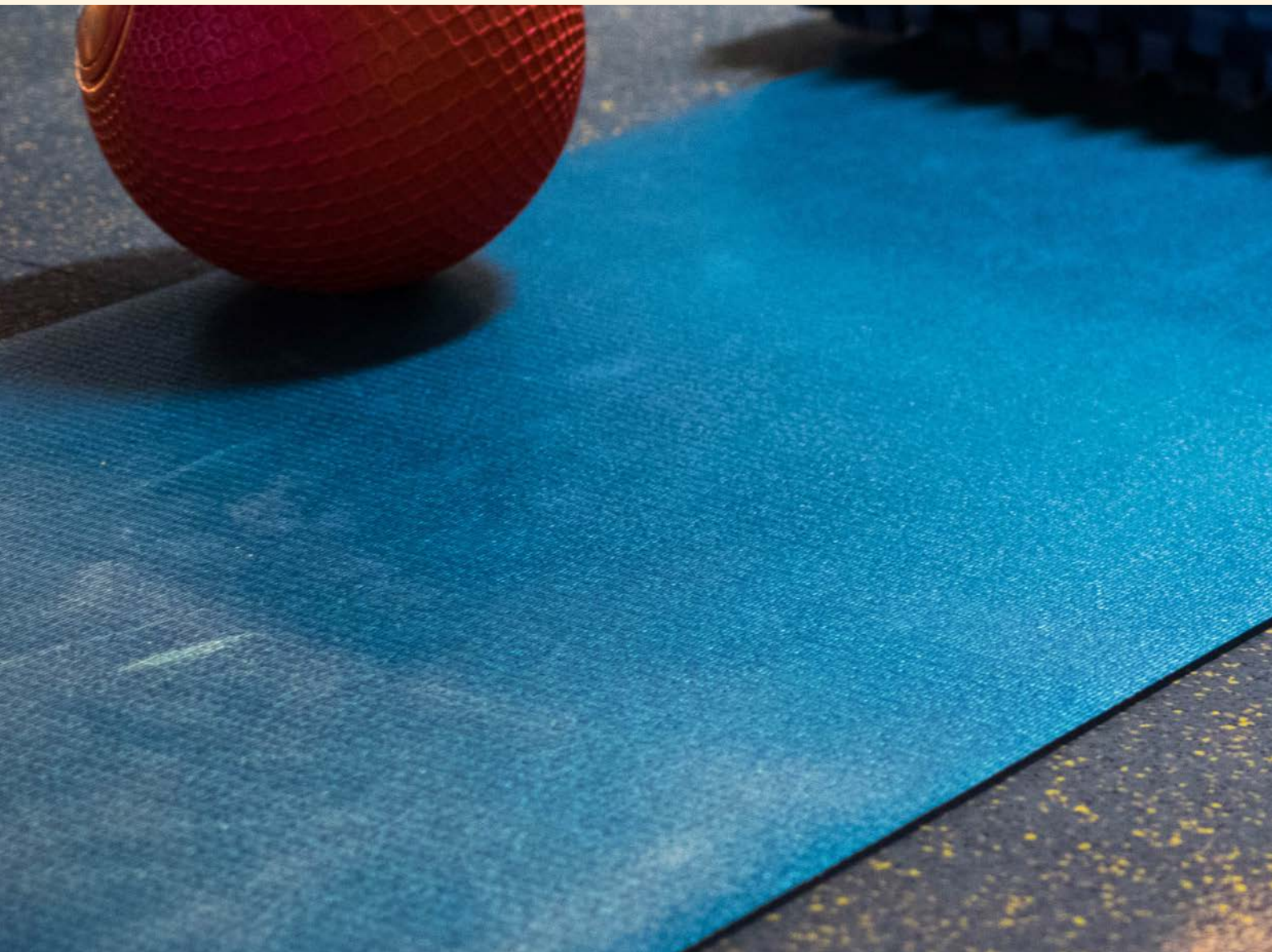

# GENIEMAT® FIT08

## Fitness Flooring Rolls & Puzzle Tiles

A protective, wear-resistant finished floor used in entryways, corridors, group fitness areas, gyms, locker rooms and spinning studios.

Our standard, the **GenieMat® FIT08** (8 mm) is also available in 6mm and 10mm nominal thicknesses. Custom orders can be made for any other thickness and combination of EPDM colours. See page 15 for EPDM colour options.

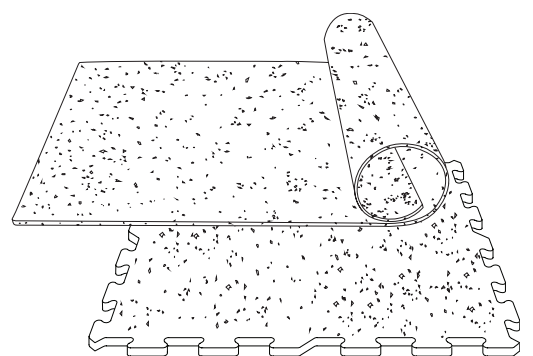





### GenieMat® FIT08 PHYSICAL PROPERTIES

TEST TYPE	ASTM	TEST RESULT
Shore hardness	D2240	>70 +/- 5
Density	D729	>65 lb/ft <sup>3</sup>
Elongation (at break)	D412	>90%
Tensile strength	D412	>300 psi
Taber abrasion	C501	0.45
Critical radiant flux	D395	Class I/II*
Flame spread	E84	135**
Smoke density	E84	<450**
Compression set	ISO 815	5% @ 72 Hrs
Coefficient of friction	D1894-95	Wet 1.20 / Dry 1.20
Tear	D624	5.71 lbf/in
Chemical resistance	F925-02	No Change

\* Class I available upon request.

\*\* Same as carpet and wood.



# COLOUR SELECTION

## GenieMat® FIT30 & GenieMat FIT70

### FUSION SERIES

GenieMat FIT tiles are manufactured by fusing a 3 mm EPDM (up to 15%) wear layer to a recycled rubber crumb base. This provides superior acoustic performance in combination with excellent wear and grip.

#### STANDARD

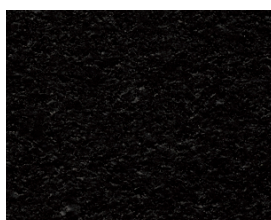

BLACK

#### 3 ALTERNATIVE PREMIUM COLOURS:

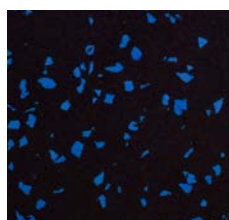

OCEAN BLUE

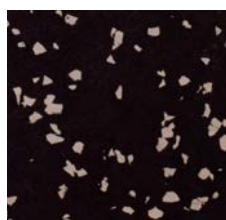

SILVER GRAY



99% MID GRAY



# GenieMat® FIT08

## STANDARD COLOURS

Made of 15% EPDM, these are available in 3 colours in roll and puzzle tile format. For more customizable flooring colour options, see below for our selection of EPDM colours.



BLACK

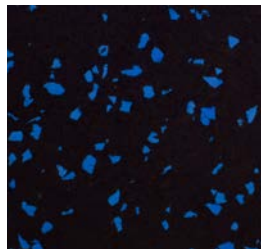

OCEAN BLUE

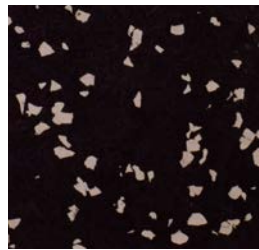

SILVER GREY

## EPDM COLOURS FOR ANY GENIEMAT® FIT FLOORING

Choose from our selection of 19 colours and combine them together to create a unique flooring blend for your project.



Black  
Crumb  
Rubber

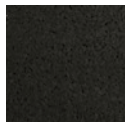

Coal

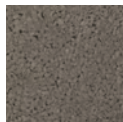

Mid Grey



Silver Grey



Ivory



Mid Brown



Light Brown



Khaki



Cork



Lemon



Lava



Bright Red



Tangerine

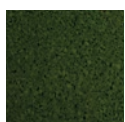

Forest Green



Eco Green



Lime Green



Royal Blue



Ocean Blue



Baby Blue

Product colours may vary.

\*Images are for representation purpose only. Other combinations can be customized.

# TEST RESULTS

TEST RESULTS				
TEST REPORT NUMBER	FINISH FLOOR	SUBFLOOR SYSTEM*	6.8 kg HARD IMPACT SOURCE (SPL OF COMBINED 63 Hz OCTAVE BAND IN dB)	45.4 kg HARD IMPACT SOURCE (SPL OF COMBINED 63 Hz OCTAVE BAND IN dB)
E5600.11	Bare	None		
E5600.12	<b>GenieMat® FIT08</b>	None		
E5600.14	<b>GenieMat FIT30</b>	None	84	95
E5600.15	<b>GenieMat FIT70</b>	None	81	84
E5600.16	<b>GenieMat xFIT70</b>	None	81	88
E5600.17	<b>GenieMat xFIT100</b>	None	80	80
E5600.26	<b>GenieMat FIT70</b>	12 mm Cement Board, <b>GenieMat FF25</b>	80	76
E5600.27	<b>GenieMat xFIT70</b>	12 mm Cement Board, <b>GenieMat FF25</b>	79	82
E5600.28	<b>GenieMat FIT30</b>	18 mm Plywood, <b>GenieMat FF70</b>	82	86
E5600.29	<b>GenieMat FIT70</b>	18 mm Plywood, <b>GenieMat FF70</b>	80	76
E5600.30	<b>GenieMat xFIT70</b>	18 mm Plywood, <b>GenieMat FF70</b>	78	81
E5600.31	<b>GenieMat FIT70</b>	18 mm Plywood, <b>GenieMat FF70LDM</b>	74	72
E5600.32	<b>GenieMat xFIT70</b>	18 mm Plywood, <b>GenieMat FF70LDM</b>	72	75
E5600.33	Bare	18 mm Plywood on 50 x 100 mm Sleepers, Mason MFS Springs	74	89
E5600.34	<b>GenieMat FIT70</b>	18 mm Plywood on 50 x 100 mm Sleepers, Mason MFS Springs	72	80
E5600.35	<b>GenieMat xFIT70</b>	18 mm Plywood on 50 x 100 mm Sleepers, Mason MFS Springs	69	82

\* All assemblies are on 152 mm concrete slab with no ceiling.

## CONTACT US

For Your Project Specific Questions

**UK** +44 1223 257770 | **Asia Pacific** +65 8452 6865 | **Middle East** +971 4 813 5501

**E.** info@pliteq.co.uk

© Pliteq (UK) LTD. 2021.

1021 <sup>®</sup> Trademarks of Pliteq Inc. The information provided is accurate to the best of our knowledge at the time of issue. However, we reserve the right to make changes when necessary without further notification. Suggested application may need to be modified to conform with local building codes and conditions. We cannot accept responsibility for products that are not used, or installed, to our specifications. All listed dimensions are nominal.



[www.pliteq.co.uk](http://www.pliteq.co.uk)