



It's not magic, it's engineering.®

Impact and Airborne Sound Control

GENIEMAT[®] FIT

For Weight Drop Impact Insulation

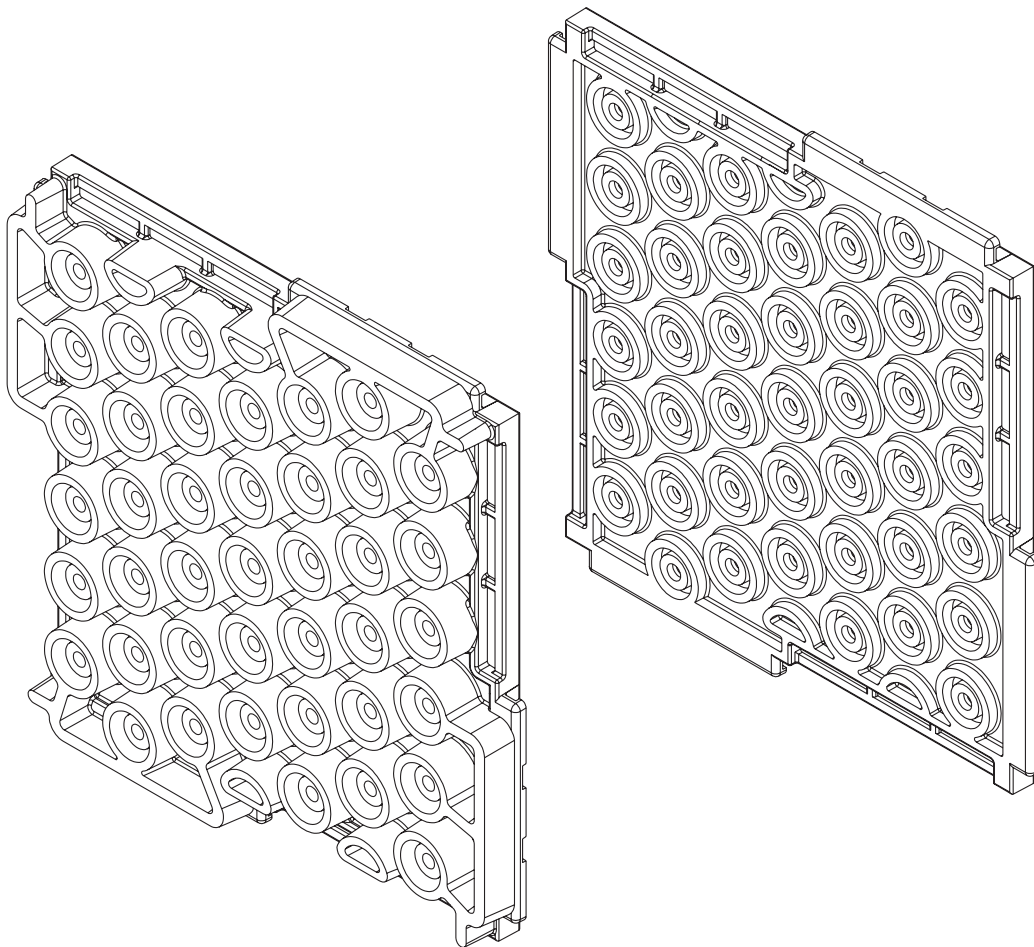

UK EDITION

Patent Pending

GENIEMAT[®] FIT

All-in-one fitness flooring

PRODUCT FEATURES

GenieMat FIT is an all-in-one fitness floor made from recycled rubber, engineered to reduce structure-borne sound and vibration transmission in concrete, wood frame and metal deck construction.

GenieMat FIT floors dramatically reduce low frequency impact noise in free weight areas, under cardio equipment and in fitness studios.

	GenieMat FIT08	GenieMat FIT30	GenieMat FIT70
Weight/sf	1.7 - 2.2 lb (0.8 - 1.0 kg)	5.2 lb (2.3 kg)	9.2 lb (4.2 kg)
Thickness	5/16" (8 mm)	1 1/4" (30 mm)	2 3/4" (70 mm)
Installed Dimension	48" x 25' (1220mm x 7620mm)	23 7/8" x 23 7/8" (607 mm x 607 mm)	23 7/8" x 23 7/8" (607 mm x 607 mm)
Product Type	Roll	Interlocking Tile	Interlocking Tile

All listed dimensions are nominal.

GenieMat FIT30 and **GenieMat FIT70** have a product and installed dimension tolerance of +/- 1/8".

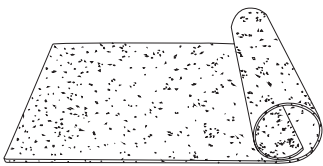

GenieMat® FIT08

APPLICATIONS

- Entryways/corridors
- Group fitness areas
- Locker rooms
- Spinning studios

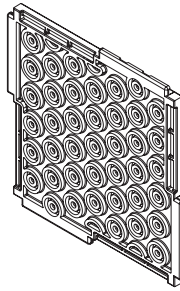

GenieMat FIT30

APPLICATIONS

- Cardio studios
- Personal training areas
- Machine areas

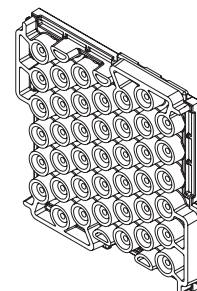

GenieMat FIT70

APPLICATIONS

- High impact studios
- Free weight/dumbbell areas

ENGINEERED FOR PERFORMANCE

GenieMat® FIT DESIGN CRITERIA

SIGNIFICANTLY REDUCES STRUCTURE-BORNE VIBRATION

- Low dynamic stiffness for improved low frequency response
- Engineered dual cylinder pedestals reduce vibration transmission
- Decreased impact force exposure level as measured using heavy/hard impact sources

SEAMLESS, INTERLOCKING FIT

- Tiles are installed in compression to have a seamless aesthetic and eliminate seam separation over time
- Seam compression of 10.3 N/mm (59 lbf/in)

DESIGN OBJECTIVES OF A LOCALLY REACTIVE TILE

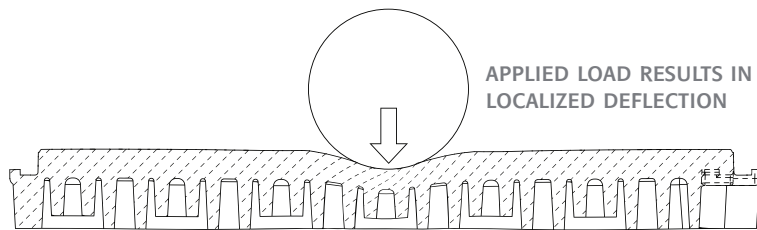

TIME DOMAIN FORCE PULSE

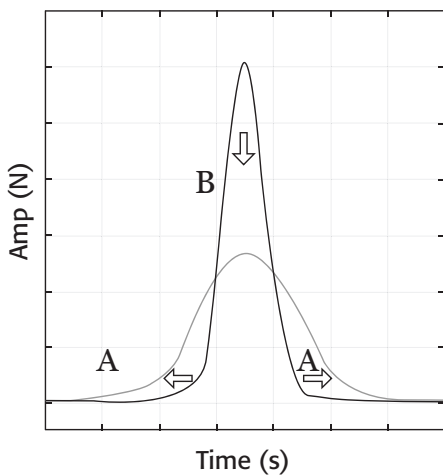

- A. Extending contact time improves lower frequency attenuation
- B. Reducing peak force value reduces overall sound pressure level

FREQUENCY DOMAIN FORCE PULSE

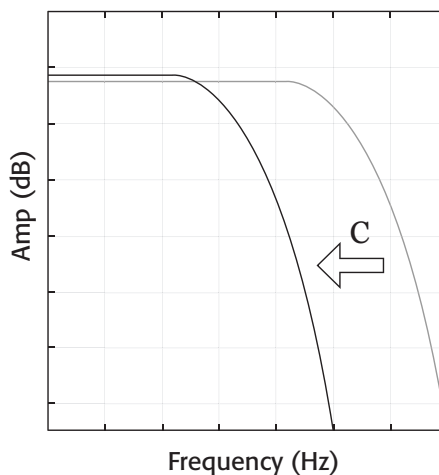

- C. Reducing 3 dB down point frequency improves lower frequency attenuation

DURABILITY

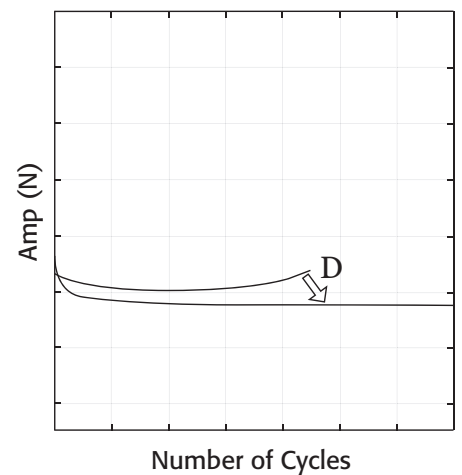

- D. Flattening out durability curve equates to improved product lifetime
- Plot of peak force values taken from repeated force pulse measurements

FORCE PULSE MEASUREMENTS OF GENIEMAT® FIT SYSTEMS

- Can be used to predict in-situ performance. Contact **Pliteq** for *Internoise 2018* paper and methodology

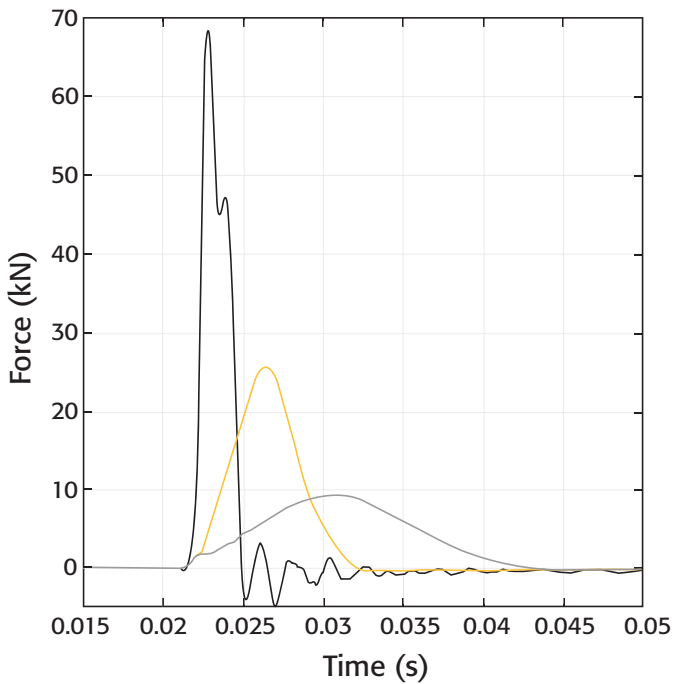

- **GenieMat FIT08**
- **GenieMat FIT30**
- **GenieMat FIT70**

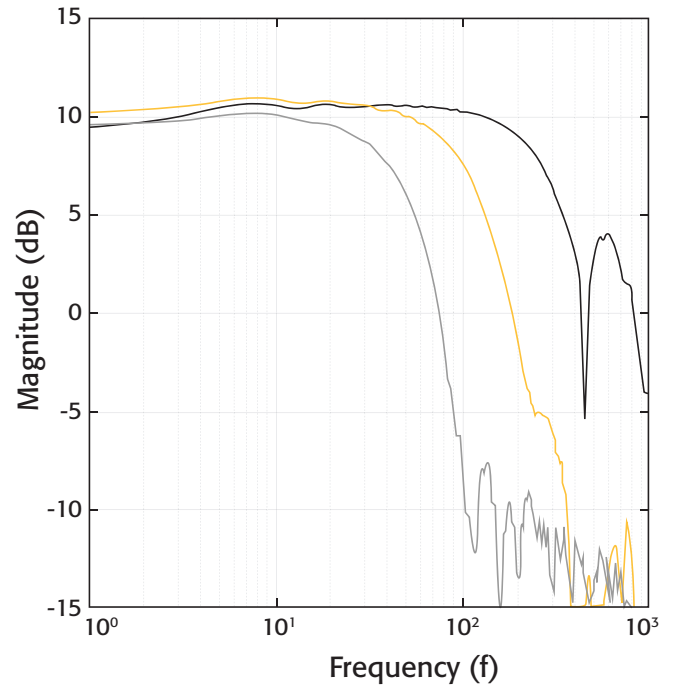

- **GenieMat FIT08**
- **GenieMat FIT30**
- **GenieMat FIT70**

ENGINEERING DESIGN CHARACTERISTICS

TEST RESULTS				
TEST DESCRIPTION	STANDARD REFERENCE	GenieMat® FIT08	GenieMat® FIT30	GenieMat® FIT70
Slip Resistance	ASTM D2047	0.90	0.81	0.81
Tensile Strength	ASTM D412	1.72 N/mm ²	0.74 N/mm ²	0.63 N/mm ²
CHPS Section 01350	ASTM D5116	Pass	Pass	Pass
Chemical Resistance	ASTM F925	No Change	No Change	No Change
Impact Force Exposure Level	ISO 10140 - Part 5	43 dB	41 dB	39 dB
Critical Radiant Flux	ASTM E648	Class I /Class II*	Class I /Class II*	Class I /Class II*

*Class I available upon request.

GENIEMAT® xFIT

GenieMat xFIT TESTING

US Patent: US 10,676,920 B2

FORCE PULSE

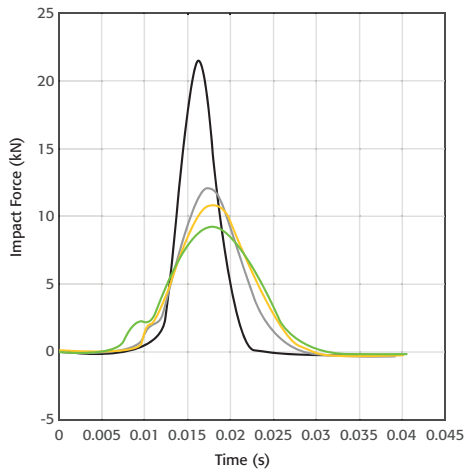

- GenieMat FIT30
- GenieMat FIT70
- GenieMat xFIT70
- GenieMat xFIT100

FATIGUE TESTING

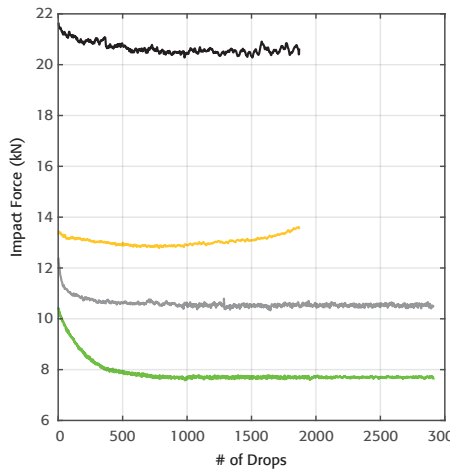

- GenieMat FIT30
- GenieMat FIT70
- GenieMat xFIT70
- GenieMat xFIT100

REBOUND PLOTS

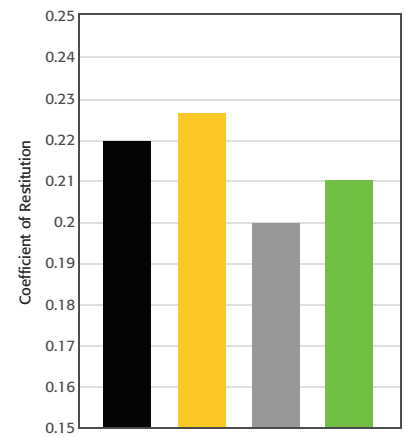

- GenieMat FIT30
- GenieMat FIT70
- GenieMat xFIT70
- GenieMat xFIT100

ENGINEERING DESIGN CHARACTERISTICS

	GenieMat xFIT70	GenieMat xFIT100
Weight/sf	4.2 kg/sf	5.3 kg/sf
Thickness	70 mm	100 mm
Product Finish	Interlocking Tile	Interlocking Tile

PLATFORMS

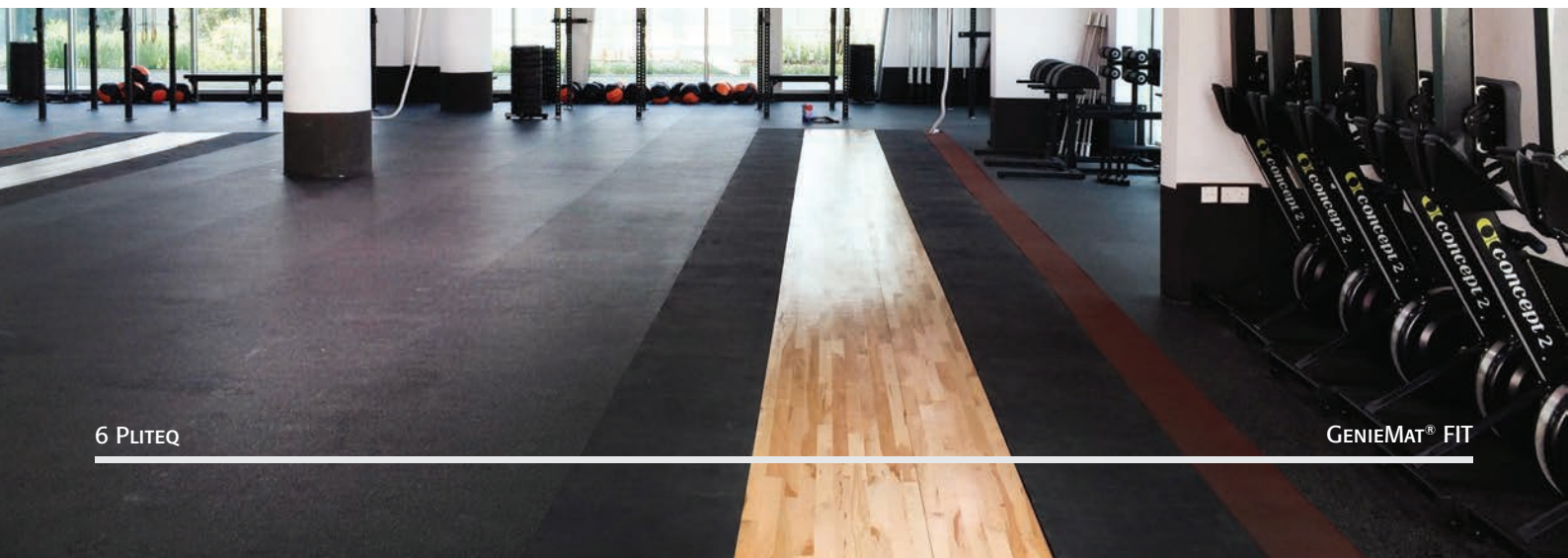

HYBRID SYSTEM

WITH **GenieMat® FIT** AND **GenieMat FF**

LOCALLY REACTIVE

APPLIED LOAD RESULTS IN LOCALIZED DEFLECTION

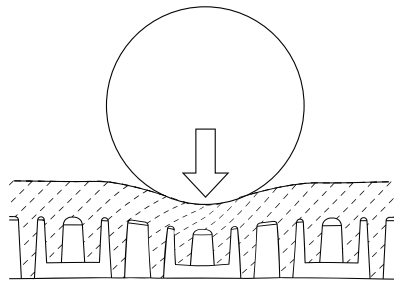

RESILIENT TILE

RESONANTLY REACTIVE

APPLIED LOAD RESULTS IN DISTRIBUTED DEFLECTION

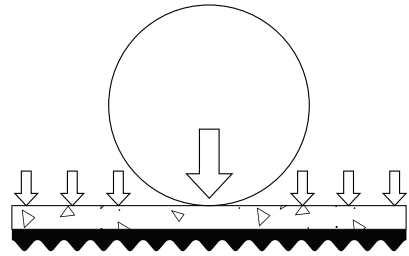

RIGID LAYER & RESILIENT UNDERLAYMENT

LOCALLY REACTIVE ABOVE RESONANTLY REACTIVE CREATES A HYBRID SYSTEM

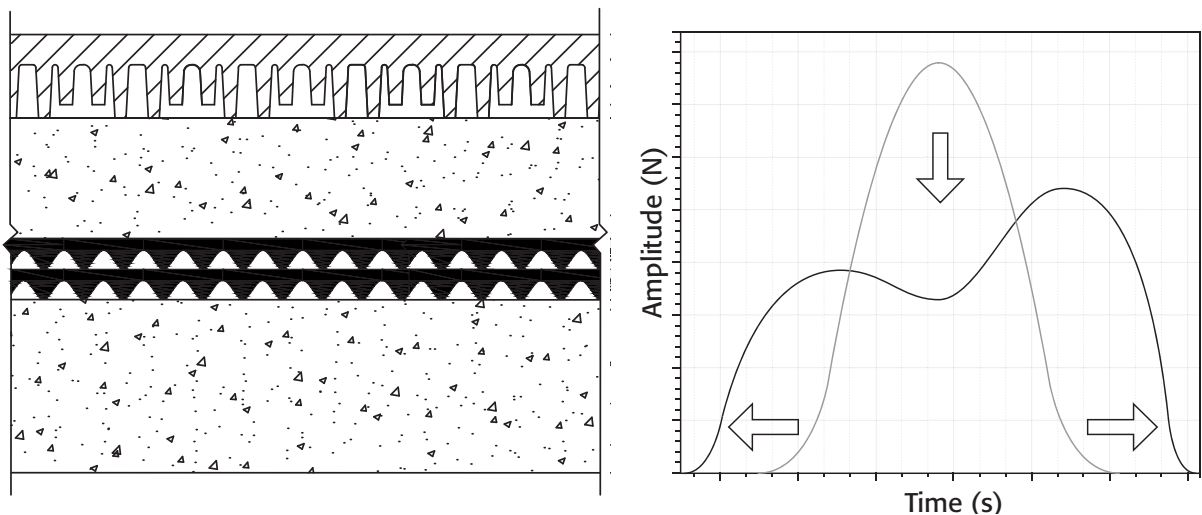

- Helps reduce impact force amplitude and increase force impulse duration
- Ideal for rhythmic excitation such as dance studios and treadmill bays

TILE DATA

**Heavy Weight Drop - Acceleration
39" (1.0 m) 15 lb (6.8 kg)**

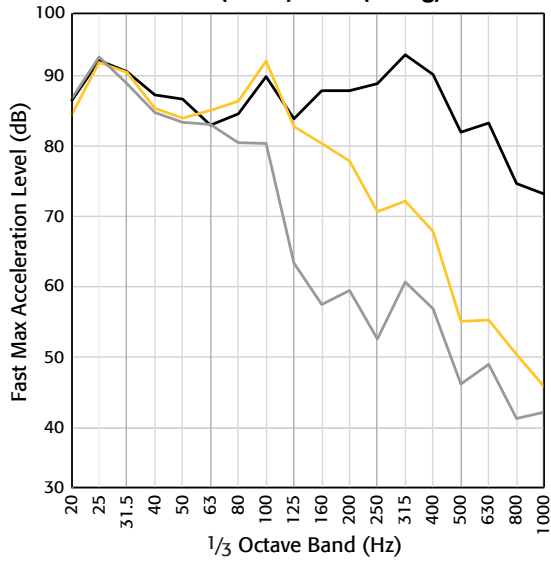

- E5600.12 **GenieMat FIT08**
- E5600.14 **GenieMat FIT30**
- E5600.15 **GenieMat FIT70**

**Heavy Weight Drop - Acceleration
39" (1.0 m) 100 lb (45.4 kg)**

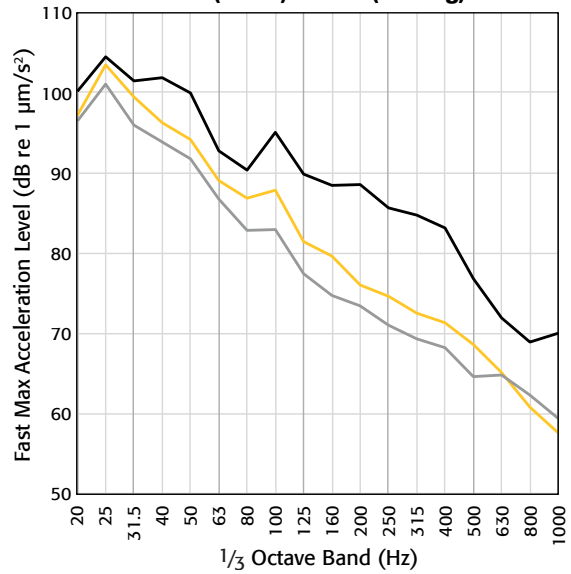

- E5600.15 **GenieMat FIT70**
- E5600.16 **GenieMat xFIT70**
- E5600.17 **GenieMat xFIT100**

PLYWOOD HYBRID

**Heavy Weight Drop - Acceleration
39" (1.0 m) 15 lb (6.8 kg)**

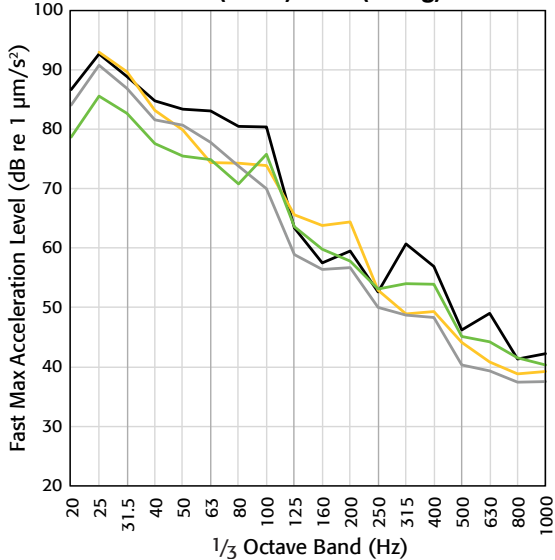

- E5600.15 **GenieMat FIT70**
- E5600.26 **GenieMat FIT70, 13 mm Cement Board, GenieMat FF25**
- E5600.29 **GenieMat FIT70, 19 mm Plywood, GenieMat FF70**
- E5600.31 **GenieMat FIT70, 19 mm Plywood, GenieMat FF70LDM**

**Heavy Weight Drop - Acceleration
39" (1.0 m) 100 lb (45.4 kg)**

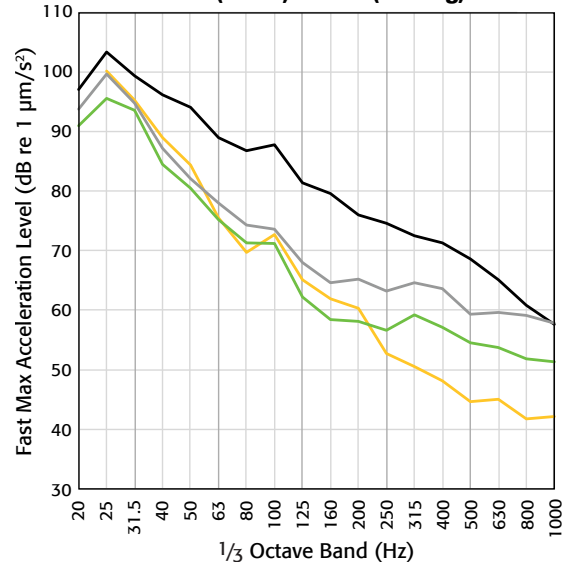

- E5600.16 **GenieMat xFIT70**
- E5600.27 **GenieMat xFIT70, 13 mm Cement Board, GenieMat FF25**
- E5600.30 **GenieMat xFIT70, 19 mm Plywood, GenieMat FF70**
- E5600.32 **GenieMat xFIT70, 19 mm Plywood, GenieMat FF70LDM**

CONCRETE HYBRID

NOTE: FCS - Floating Concrete Slab

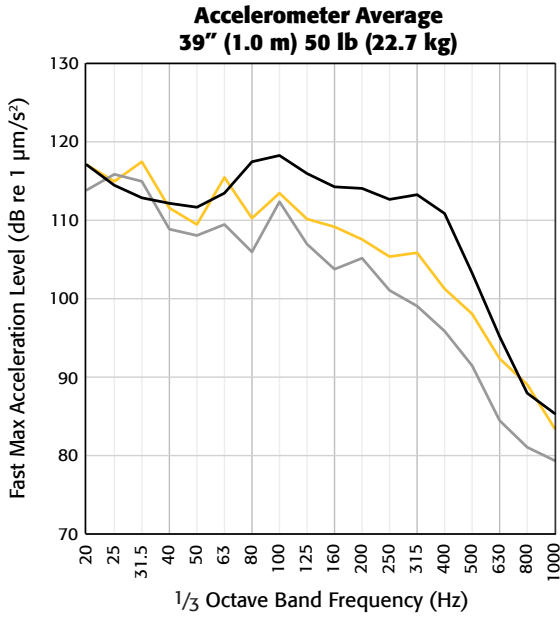

- A1-008867-01F **GenieMat FIT08**, 102 mm FCS, **GenieMat FF50**
- A1-008867-04F **GenieMat FIT08**, 102 mm FCS, **GenieMat FF70**
- A1-008867-05F **GenieMat FIT08**, 102 mm FCS, **GenieMat FF70LDM**

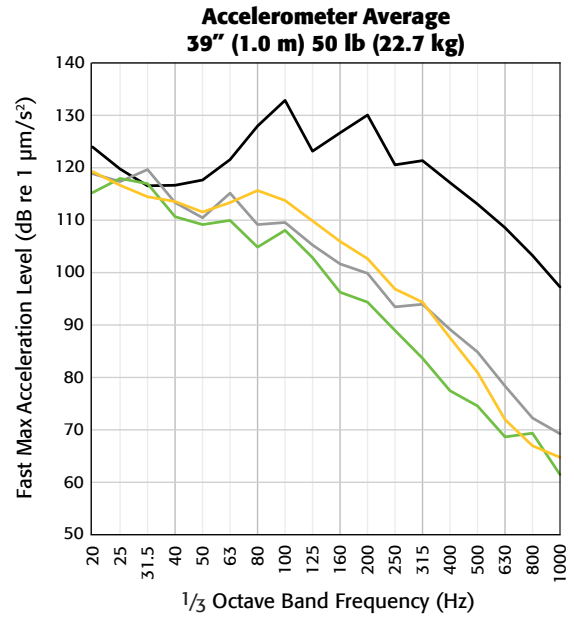

- A1-008867-00F **GenieMat FIT30**
- A1-008867-01F **GenieMat FIT30**, 102 mm FCS, **GenieMat FF50**
- A1-008867-04F **GenieMat FIT30**, 102 mm FCS, **GenieMat FF70**
- A1-008867-05F **GenieMat FIT30**, 102 mm FCS, **GenieMat FF70LDM**

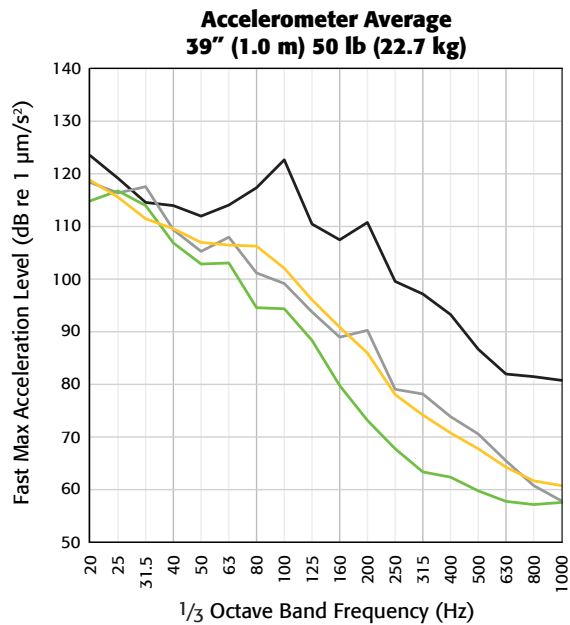

- A1-008867-00F **GenieMat FIT70**
- A1-008867-01F **GenieMat FIT70**, 102 mm FCS, **GenieMat FF50**
- A1-008867-04F **GenieMat FIT70**, 102 mm FCS, **GenieMat FF70**
- A1-008867-05F **GenieMat FIT70**, 102 mm FCS, **GenieMat FF70LDM**

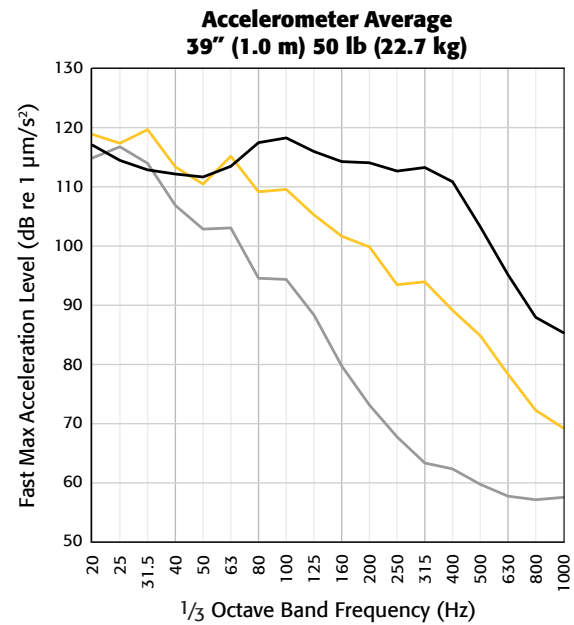

- A1-008867-01F **GenieMat FIT08**, 102 mm FCS, **GenieMat FF50**
- A1-008867-04F **GenieMat FIT30**, 102 mm FCS, **GenieMat FF70**
- A1-008867-05F **GenieMat FIT70**, 102 mm FCS, **GenieMat FF70LDM**

GENIEMAT[®] TMIP

TREADMILL ISOLATION PADS

U.S Patent No.: 8,113,495
 Canadian Patent No.: 2,505,938

GenieMat TMIP are inherently non-slip. Custom sizes are available for other special applications.

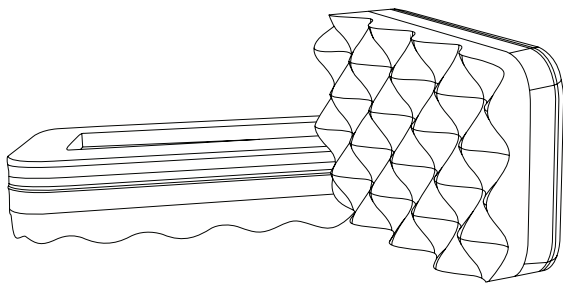

STANDARD THICKNESS	51 mm
STANDARD SIZES	127 mm x 457 mm – Front Mounts 127 mm x 178 mm – Rear Mounts
STATIC DEFLECTION	Lightweight case: 45 kg user (10.1 kPa load deflection): 1 to 2 cm Heavyweight case: 136 kg user (19.0 kPa load deflection): 2 to 3 cm

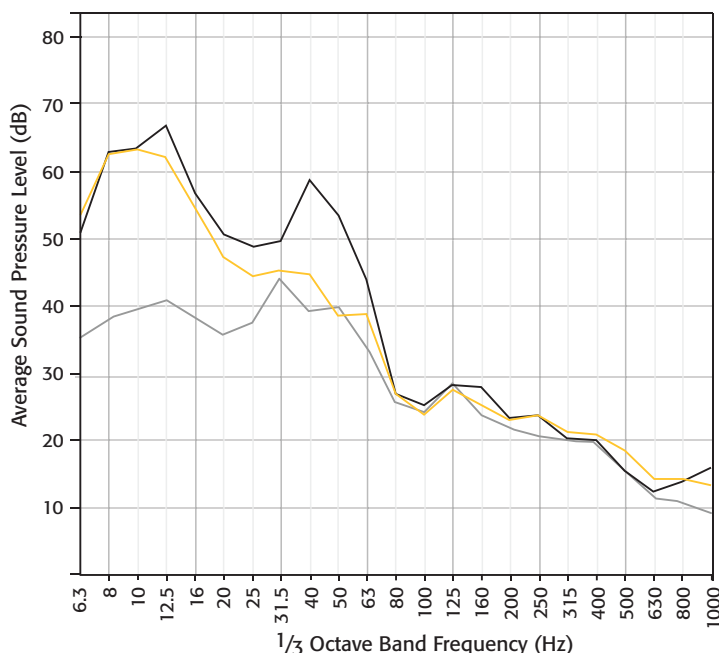

ENGINEERED TO REDUCE LOW FREQUENCY IMPACT

Field Measured Average Sound Pressure Levels

- Running with 1 layer of 18 mm rubber
- Running with **GenieMat[®] TMIP** on 1 layer of 18 mm rubber
- Ambient sound level, no running

GENIEMAT[®] WSI

WEIGHT STACK ISOLATORS

Patent pending

GenieMat WSI isolates impact noise from selectorized machines.

- Reduce impact noise at the source
- Customized size to fit every weight stack
- Installation does not require machine disassembly

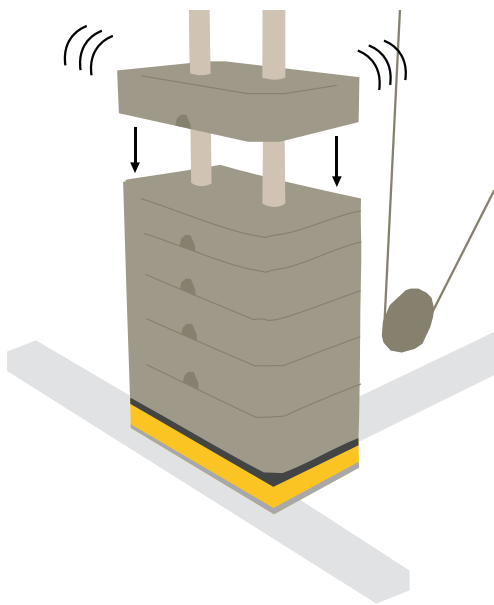

Force Pulse Comparison
20" (0.5 m) 50 lb (22.7 kg)

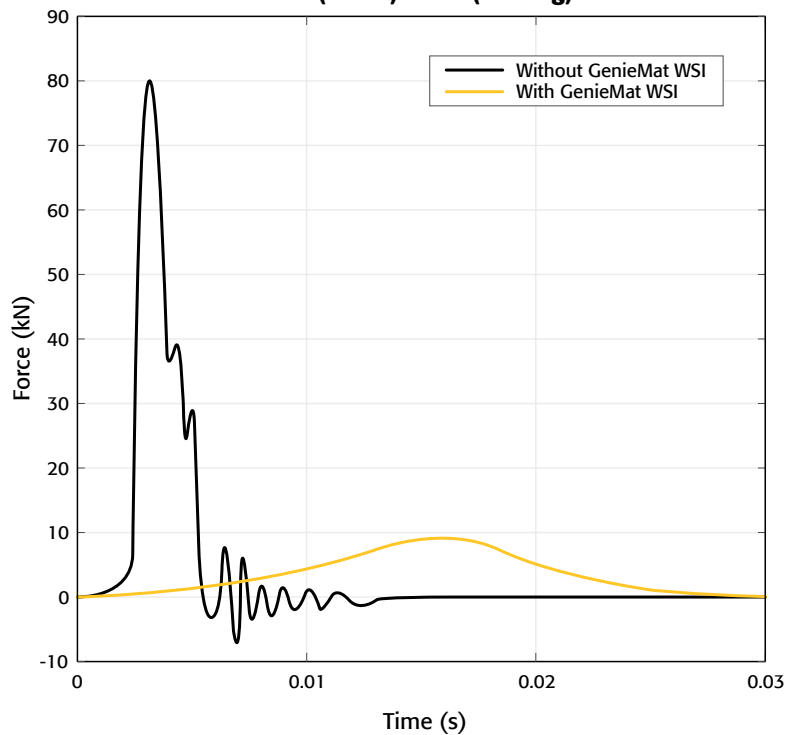

GENIEMAT[®] FIT ACCESSORIES

- Customized on site to accommodate any threshold
- Accessories for all installation types
- Corner transitions created in the field
- **GenieMat FASHM** adhesive
- Load plates available to accommodate high point loads



GENIEMAT[®] FIT08

Fitness Flooring Rolls

A protective, wear-resistant finished floor used in entryways, corridors, group fitness areas, locker rooms and spinning studios.

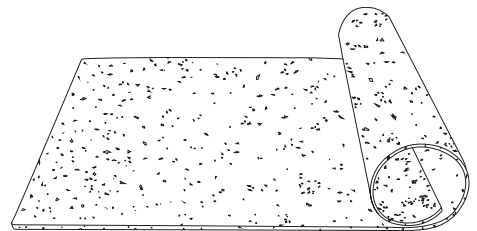



GenieMat® FIT08 PHYSICAL PROPERTIES

TEST TYPE	ASTM	TEST RESULT
Shore hardness	D2240	>70 +/- 5
Density	D729	>65 lb/ft ³
Elongation (at break)	D412	>90%
Tensile strength	D412	>300 psi
Taber abrasion	C501	0.45
Critical radiant flux	D395	Class I/II*
Flame spread	E84	135**
Smoke density	E84	<450**
Compression set	ISO 815	5% @ 72 Hrs
Coefficient of friction	D1894-95	Wet 1.20 / Dry 1.20
Tear	D624	5.71 lbf/in
Chemical resistance	F925-02	No Change

* Class I available upon request.

** Same as carpet and wood.

COLOR SELECTION

GenieMat® FIT

STANDARD COLORS

GenieMat FIT tiles are manufactured by fusing a durable wear layer to a recycled rubber crumb base. This provides superior acoustic performance in combination with excellent wear and grip. **GenieMat FIT30** tiles, **GenieMat FIT70** tiles and **GenieMat FITo8** rolls are available in 8 standard color options, see below.

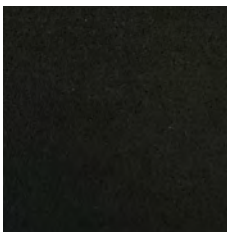

BLACK



SILVER

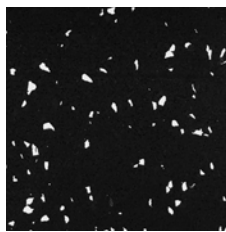

WHITE



BLUE

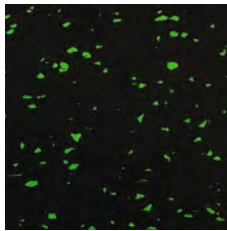

GREEN

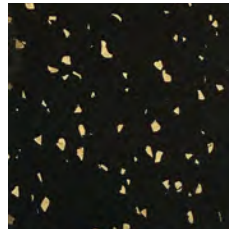

CORK

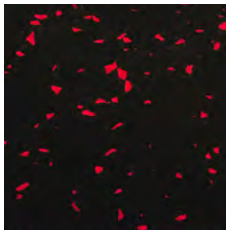

RED

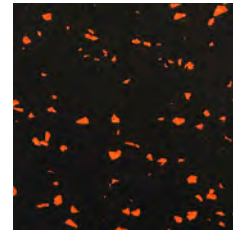

ORANGE

PREMIUM COLORS

GenieMat FIT70 tiles and **GenieMat FIT30** tiles are also available in 6 premium color options. For additional custom color formulations please contact your local Pliteq representative (minimum order quantities may apply).

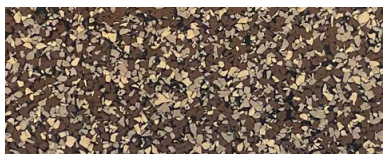

MULCH

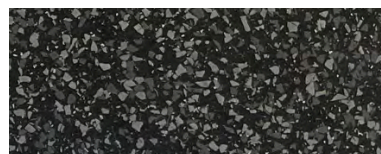

OBSIDIAN



GRANITE

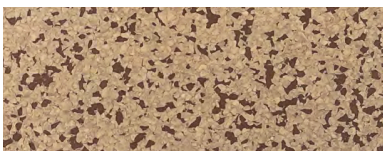

SANDSTONE

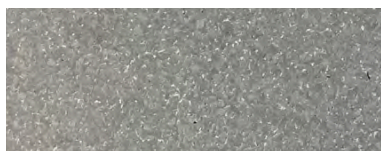

CONCRETE

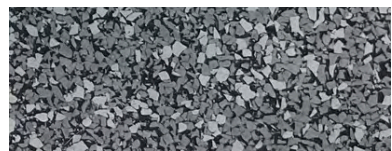

MARBLE

*Product colors may vary. Images are for representation purpose only.

TEST RESULTS

TEST RESULTS				
TEST REPORT NUMBER	FINISH FLOOR	SUBFLOOR SYSTEM*	6.8 kg HARD IMPACT SOURCE (SPL OF COMBINED 63 Hz OCTAVE BAND IN dB)	45.4 kg HARD IMPACT SOURCE (SPL OF COMBINED 63 Hz OCTAVE BAND IN dB)
E5600.11	Bare	None		
E5600.12	GenieMat® FIT08	None		
E5600.14	GenieMat FIT30	None	84	95
E5600.15	GenieMat FIT70	None	81	84
E5600.16	GenieMat xFIT70	None	81	88
E5600.17	GenieMat xFIT100	None	80	80
E5600.26	GenieMat FIT70	12 mm Cement Board, GenieMat FF25	80	76
E5600.27	GenieMat xFIT70	12 mm Cement Board, GenieMat FF25	79	82
E5600.28	GenieMat FIT30	18 mm Plywood, GenieMat FF70	82	86
E5600.29	GenieMat FIT70	18 mm Plywood, GenieMat FF70	80	76
E5600.30	GenieMat xFIT70	18 mm Plywood, GenieMat FF70	78	81
E5600.31	GenieMat FIT70	18 mm Plywood, GenieMat FF70LDM	74	72
E5600.32	GenieMat xFIT70	18 mm Plywood, GenieMat FF70LDM	72	75
E5600.33	Bare	18 mm Plywood on 50 x 100 mm Sleepers, Mason MFS Springs	74	89
E5600.34	GenieMat FIT70	18 mm Plywood on 50 x 100 mm Sleepers, Mason MFS Springs	72	80
E5600.35	GenieMat xFIT70	18 mm Plywood on 50 x 100 mm Sleepers, Mason MFS Springs	69	82

* All assemblies are on 152 mm concrete slab with no ceiling.

CONTACT US

For Your Project Specific Questions

UK +44 1223 257770 | **Asia Pacific** +65 8452 6865 | **Middle East** +971 4 813 5501

E. info@pliteq.co.uk

© Pliteq (UK) LTD. 2021.

¹⁰²¹ [®] Trademarks of Pliteq Inc. The information provided is accurate to the best of our knowledge at the time of issue. However, we reserve the right to make changes when necessary without further notification. Suggested application may need to be modified to conform with local building codes and conditions. We cannot accept responsibility for products that are not used, or installed, to our specifications. All listed dimensions are nominal.



www.pliteq.co.uk