



It's not magic, it's engineering.®

Impact and Airborne Sound Control

GENIEMAT® FF

Floating Floor Systems for Airborne
& Impact Sound and Vibration Isolation

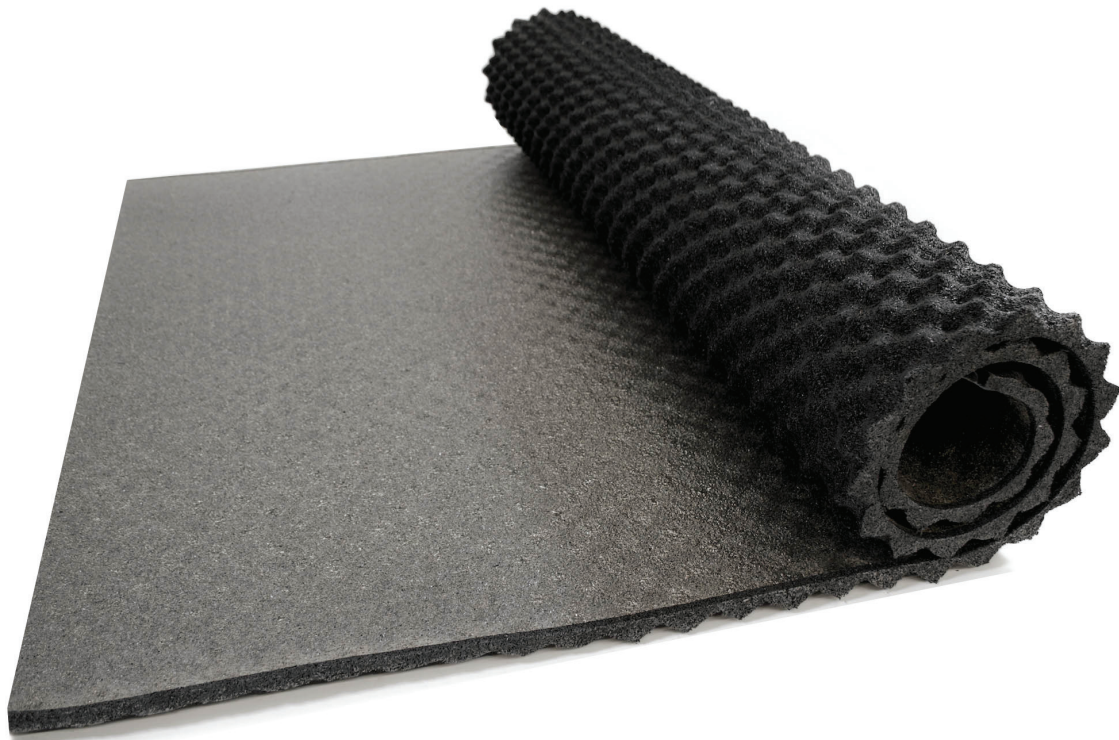

UK EDITION

GENIEMAT[®] FF

The next generation of acoustic floating floor

PRODUCT FEATURES

- Continuous underlayment system that limits surface area contact down to 4% at 1400 kg/m²
- Achieves low natural frequency with systems available as low as 6 Hz
- Can be safely loaded over a wide range up to 100 kg/cm²
- Composed of 92% recycled rubber content
- Helps to achieve HEAO5 BREEAM credits
- Mould, bacteria, fungi, and water resistant
- Penetrations for pipes, ductwork, electrical conduits, and drains are easily accommodated
- Rolls out quickly and is easy to install without the need for adhesive
- Can be used directly under screed, lightweight, or normal weight concrete with no plywood formwork required

GenieMat FF is used for multiple applications. Contact our engineers for your project specific questions.

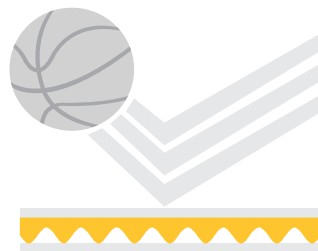
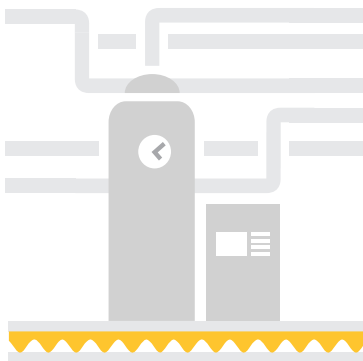

EASY INSTALLATION

ROLL IT OUT - TAPE THE SEAMS - READY TO POUR

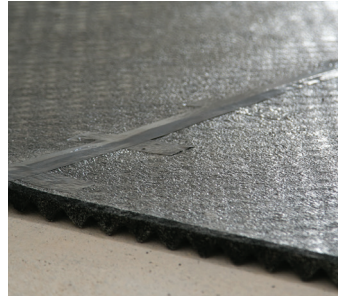

Step 1

Step 2

Step 3

Step 4

After installing perimeter isolation strips on the base of the walls, unroll **GenieMat® FF**.

Duct tape all joints and seams, including between the perimeter isolation strips and the **GenieMat FF**.







Pour screed, lightweight or normal weight concrete topping.

Prepare concrete surface for floor finish.

SIGNIFICANTLY IMPROVES INSTALLATION EFFICIENCY

STEPS	GENIEMAT® FF ROLL OUT SYSTEM	PLYWOOD FORMWORK ISOLATOR BASED SYSTEMS	SPRING JACK-UP TYPE SYSTEM
1	Install GenieMat PMI	Design isolator layout	Coordinate load requirements with associated trades
2	Roll out GenieMat FF	Install perimeter isolation	Design isolator layout based on equipment placement
3	Tape the seams	Roll out mineral fiber matting with fiberglass isolators	Install perimeter Isolation
4	Layout reinforcement and pour concrete	Install additional isolators based on load design	Verify equipment placement, snap chalk lines and spray paint isolator locations
5		Check isolators orientation and location	Layout clear polyethylene plastic sheathing
6		Cut and install plywood formwork	Layout isolators and place rebar grid
7		Install steel connecting corner plates	Pour concrete and cure to 17.2 MN/m ² minimum
8		Layout reinforcement, waterproof membrane and pour concrete	Remove all isolator cover plates
9			To raise slab 50 mm, complete 2 turns of each isolator 8-10 times
10			Replace cover plates and pour additional floor levelling compound

GENIEMAT® FF PHYSICAL PROPERTIES

PLAN VIEW	PRODUCT	THICKNESS	DIMENSION	WEIGHT	AREA
	GenieMat FF06	nom. 6 mm	Rollgood: 1.2 m wide, 9.1 m long	36 kg/roll	11.1 m ²
	GenieMat FF10	nom. 10 mm	Rollgood: 1.2 m wide, 9.1 m long	59 kg/roll	11.1 m ²
	GenieMat FF17	nom. 17 mm	Rollgood: 1.2 m wide, 4.6 m long	47 kg/roll	5.6 m ²
	GenieMat FF25	nom. 25 mm	Rollgood: 1.2 m wide, 4.6 m long	60 kg/roll	5.6 m ²
	GenieMat FF50	nom. 51 mm	Rollgood: 1.2 m wide, 4.6 m long	82 kg/roll	2.8 m ²
	GenieMat FF75	nom. 75 mm	Rollgood: 1.2 m wide, 4.6 m long	180 kg/roll	1.9 m ²

COMPRESSIBLE ELASTOMER TECHNOLOGY ALLOWS FOR LOW NATURAL FREQUENCY AT LOW LOADS

Typical vulcanized, natural, and neoprene rubber isolators are defined as incompressible. They require heavy mass loading in order to obtain adequate deflection, and consequently, vibration isolation. For applications where minimum loading criteria are not met, data shows the systems do not perform well.

Fiberglass isolators are comprised of rigid particles that lose elasticity when compressed. Data shows a dramatic performance degradation over time.

GENIEMAT[®] FF PROPERTIES

PRODUCT	100 mm Concrete (2.4 kN/m ² Dead Load)			Typical Loading (19.2 kN/m ² dead + live load)		
	NATURAL FREQUENCY (HZ)	10 HZ DYNAMIC STIFFNESS (N/MM/MM ²)	CRITICAL DAMPING RATIO	NATURAL FREQUENCY (HZ)	10 HZ DYNAMIC STIFFNESS (N/MM/MM ²)	CRITICAL DAMPING RATIO
GenieMat FF06	27	0.0068	9.5%	25	0.047	8.4%
GenieMat FF10	25	0.0059	9.7%	22	0.037	9.6%
GenieMat FF17	23	0.0053	12.5%	18	0.025	11.2%
GenieMat FF25	22	0.0045	11.5%	16	0.020	10.8%
GenieMat FF50	18	0.0030	10.2%	12	0.011	9.7%
GenieMat FF75	16	0.0022	9.6%	10	0.008	9.1%

DESIGN PARAMETERS OF GENIEMAT FF SYSTEMS

System Natural Frequency vs. Load

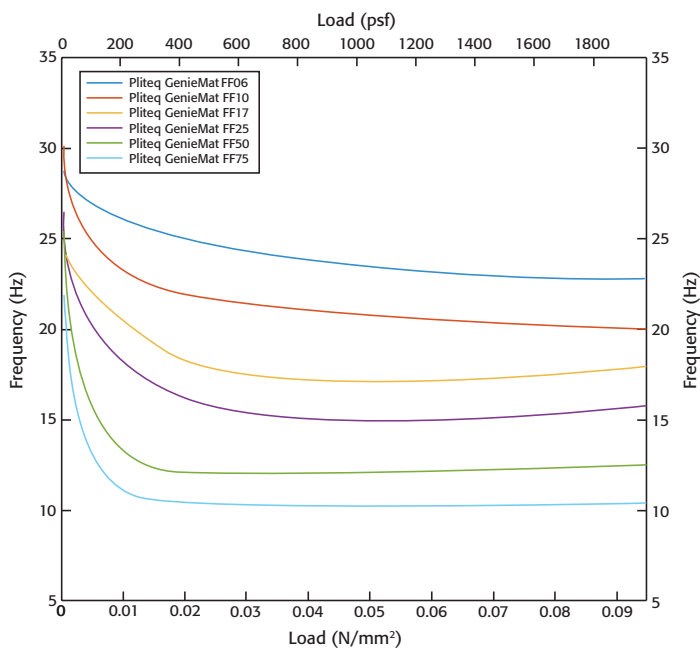

Deflection vs. Load

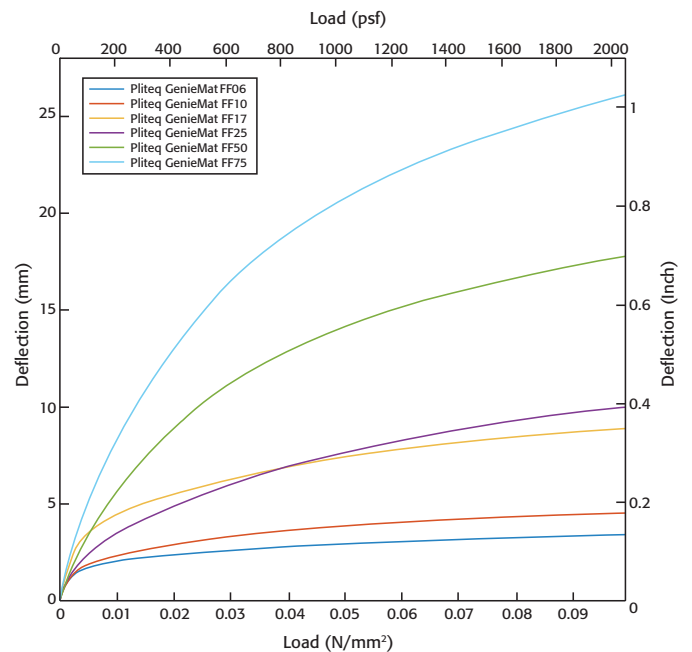

GENIEMAT® FF ACOUSTIC TEST DATA

150 mm STRUCTURAL SLAB WITH FLOATING CONCRETE TOPPING

100 mm Concrete Topping on GenieMat FF25 on 150 mm Structural Slab

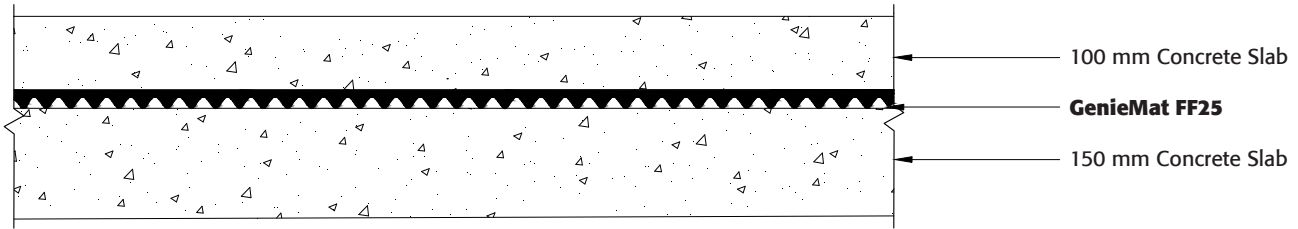

100 mm Concrete Topping on GenieMat FF50 on 150 mm Structural Slab

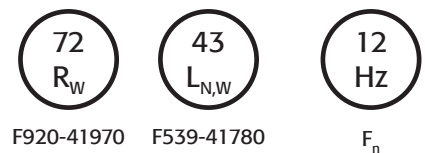
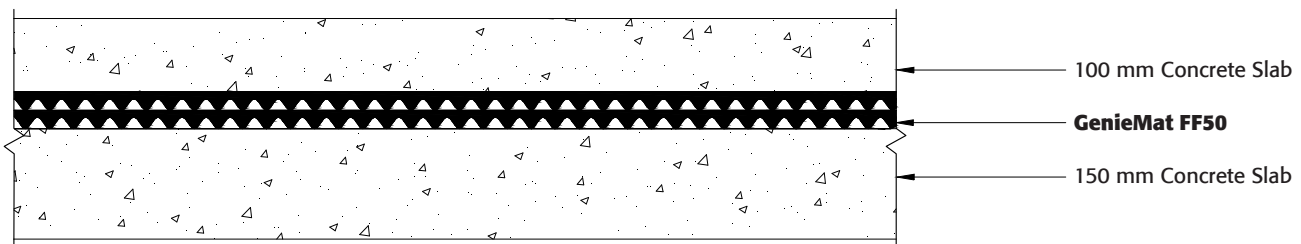

100 mm Concrete Topping on GenieMat FF75 on 150 mm Structural Slab

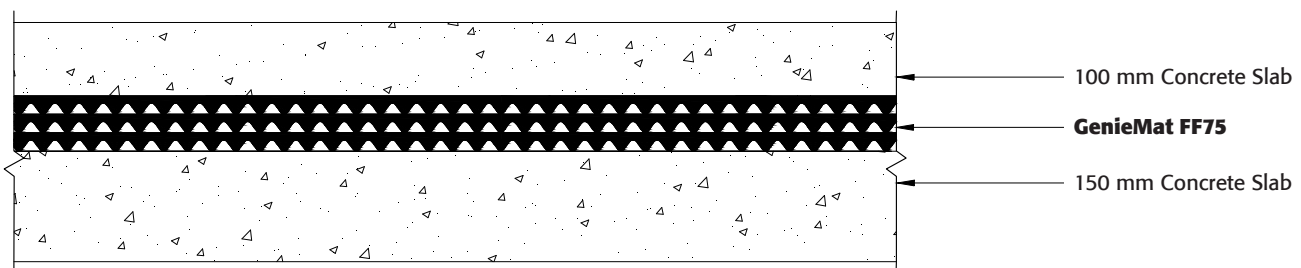

GENIEMAT® FF ACOUSTIC TEST DATA

60 mm Screed on GenieMat FF06

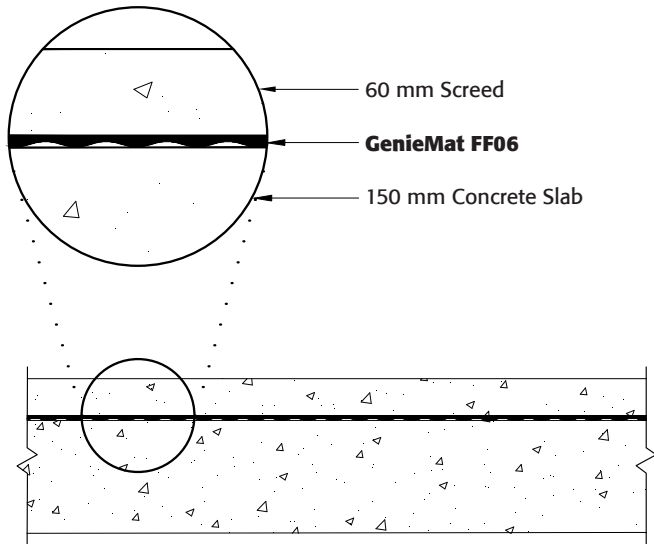

59 R_w 52 $L_{N,W}$
 F289-41701 F290-41701

60 mm Screed on GenieMat FF10

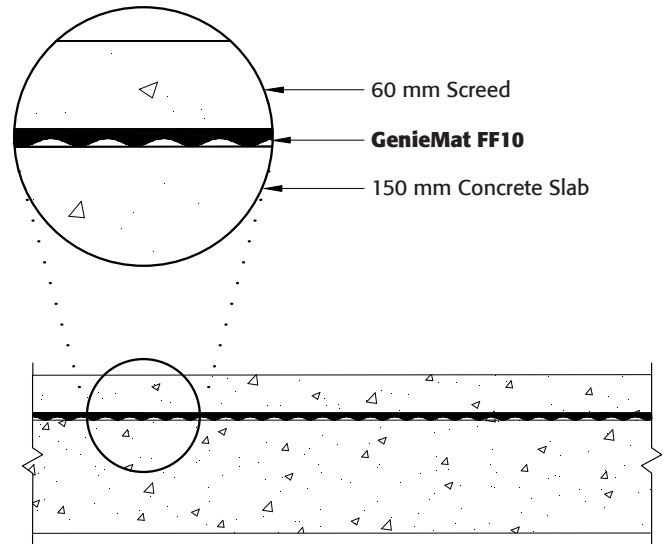

59 R_w 51 $L_{N,W}$
 F292-41702 F291-41702

60 mm Screed on GenieMat FF17

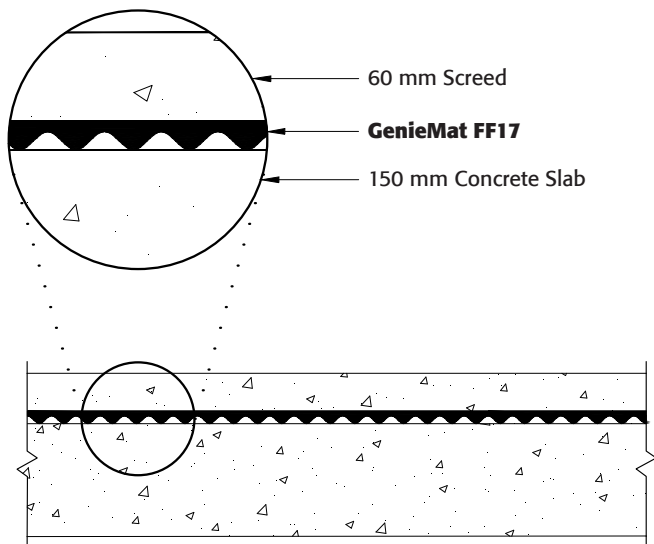

60 R_w 49 $L_{N,W}$
 F293-41702 F294-41702

60 mm Screed on GenieMat FF25

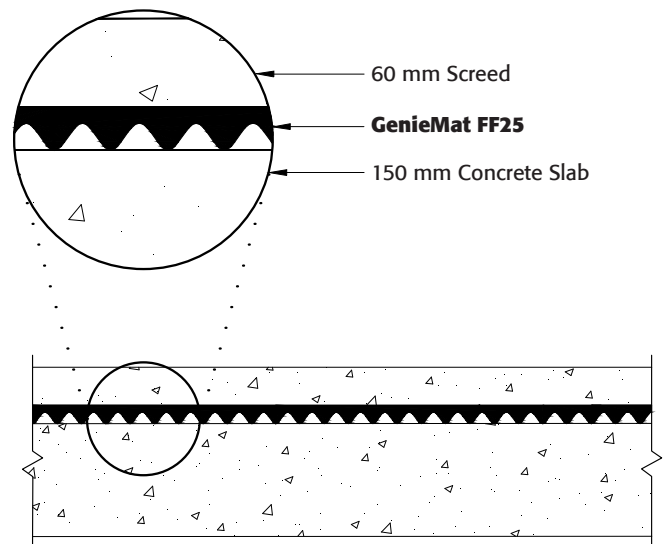

61 R_w 47 $L_{N,W}$
 F296-41702 F295-41702

GENIEMAT® FF ACOUSTIC TEST DATA

150 mm CONCRETE SLAB WITH PLYWOOD TOPPING

2 Layers of Plywood on GenieMat FF50

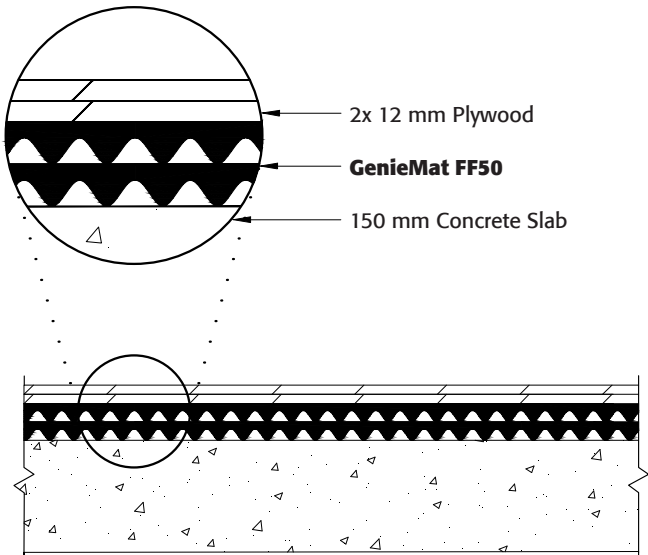

59
 R_w

54
 $L_{N,W}$

B3498.13

3 Layers of Plywood on GenieMat FF50

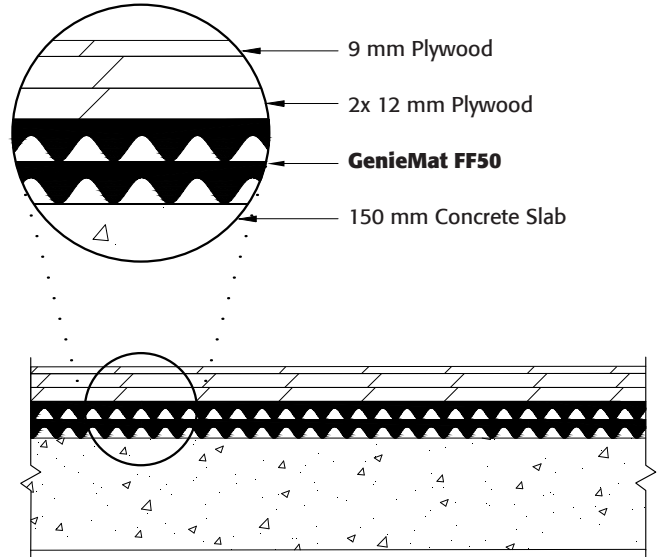

59
 R_w

52
 $L_{N,W}$

5014148

7014204

2 Layers of AdvanTech® on GenieMat FF25

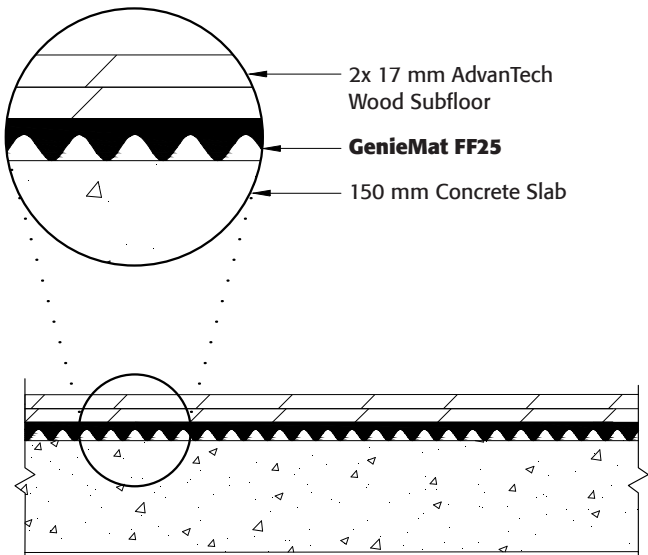

57
 R_w

53
 $L_{N,W}$

G2953.04

50 mm AdvanTech Cement Board Raft on GenieMat FF25

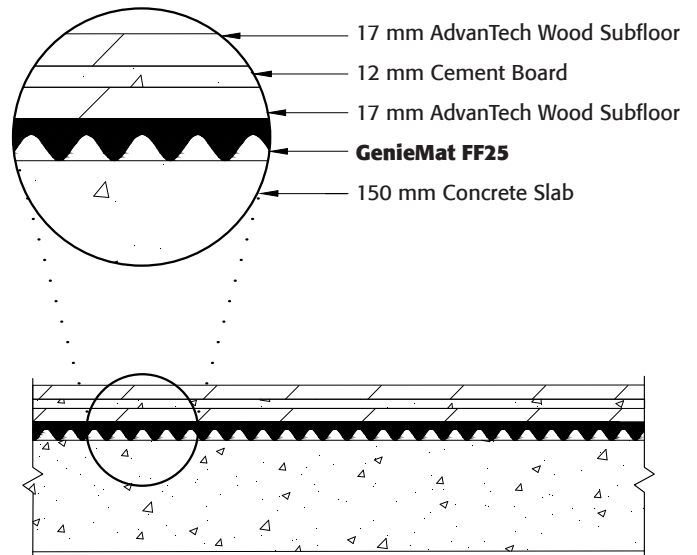

57
 R_w

53
 $L_{N,W}$

G2953.05

GENIEMAT® FF ACOUSTIC TEST DATA

CROSS LAMINATED TIMBER ASSEMBLIES

175 mm Cross Laminated Timber with 100 mm Concrete Topping on GenieMat FF25

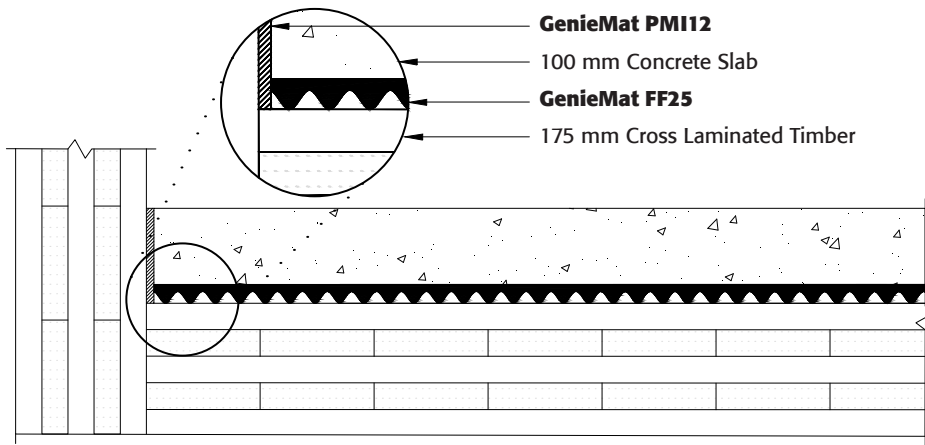

57 R_w 60 $L_{N,W}$
 F5500.08

175 mm Cross Laminated Timber with 50 mm Screed Topping on GenieMat FF25

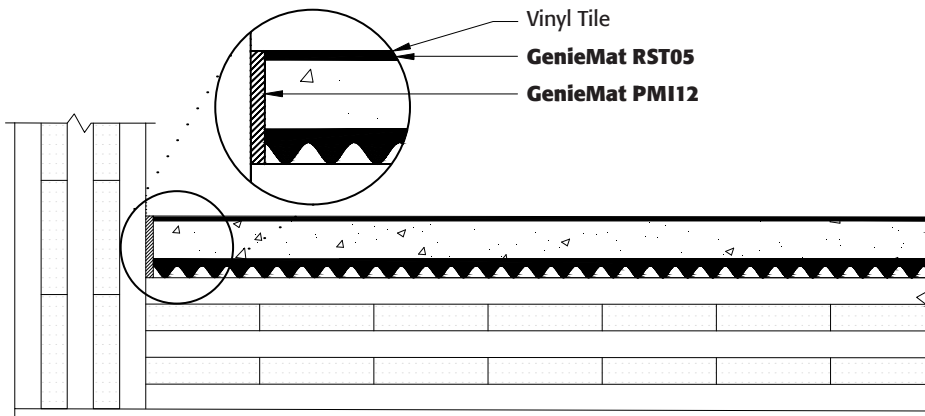

53 R_w 58 $L_{N,W}$
 F6279.14

175 mm Cross Laminated Timber with 100 mm Concrete Topping on GenieMat FF50

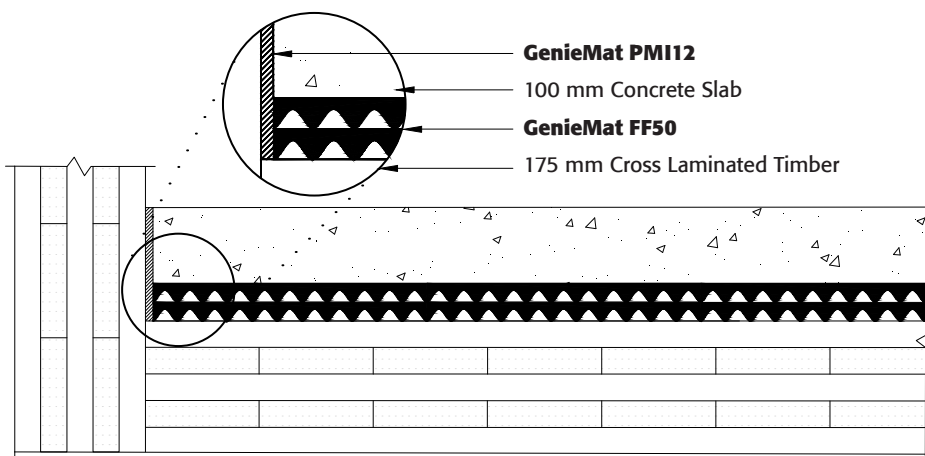

59 R_w 56 $L_{N,W}$
 F5500.10

GENIEMAT[®] FF70

Modular Panelized Floating Floor Systems

OVERVIEW

Situations which involve:

- Multiple sources of noise and vibration
- Dynamic loads, and;
- Large ranges of dead and live loads

Require a system that is easily customized, easily installed on-site, but not to the detriment of airborne, impact, and vibration isolation.

GenieMat FF70 modular panelized floating floor systems provide a prefabricated and modular panel for ease of install and guaranteed placement of the isolators.



FEATURES AND BENEFITS

- Achieves low natural frequency with systems available as low as 6 Hz
- Customizable isolators
- Adaptable height to reduce air stiffness
- Can be used directly under gypsum, lightweight, or normal weight concrete
- Can be used directly under plywood, OSB, or cement board
- Comes in easy to handle panels -nominal 2' x 2' (610 x 610mm)
- Shiplap edge design lets you quickly and easily fit panels into place
- Sturdy 5/8" (15 mm) engineered wood formwork
- Installed over wood or concrete subfloors
- No specialized installers required

GENIEMAT® FF70-9R

- Panels are made with 2" thick isolation pads embedded in a layer of acoustical insulation
- Natural frequency down to 10 Hz
- Subfloor contact area with the floor is reduced by 96%
- $\Delta L_{n,w}$ 35



GENIEMAT FF70LDM

- Panels are made with 2" thick Low Dynamic Modulous proprietary Pliteq elastomer embedded in a layer of acoustical insulation
- Natural frequency down to 6 Hz
- Sub floor contact area with the floor is reduced by 96%
- $\Delta L_{n,w}$ 44



DESIGN PARAMETERS OF GENIEMAT FF70 SYSTEMS

Airborne Sound Transmission Lightweight vs Heavyweight Topping

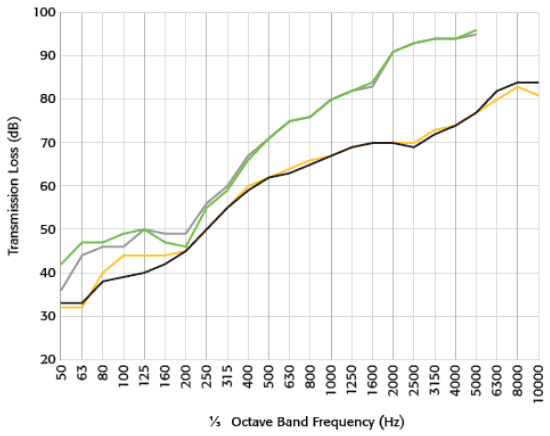

- Plywood - 19mm, GenieMat FF70 - 70mm, Concrete Slab - 150mm, R_w 61dB
- Plywood - 19mm, GenieMat FF70LDM - 70mm, Concrete Slab - 152mm, R_w 63dB
- Concrete Topping - 100mm, GenieMat FF70 - 70mm, Concrete Slab - 150mm, R_w 67dB
- Concrete Topping - 100mm, GenieMat FF70LDM - 70mm, Concrete Slab - 150mm, R_w 68dB

Impact Sound Transmission Lightweight vs Heavyweight Topping

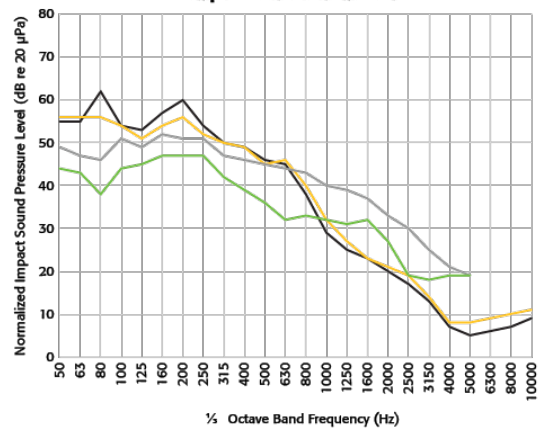

- Plywood - 19mm, GenieMat FF70 - 70mm, Concrete Slab - 152mm, $L_{n,w}$ 48dB
- Plywood - 19mm, GenieMat FF70LDM - 70mm, Concrete Slab - 152mm, $L_{n,w}$ 46dB
- Concrete Topping - 100mm, GenieMat FF70 - 70mm, Concrete Slab - 150mm, $L_{n,w}$ 45dB
- Concrete Topping - 100mm, GenieMat FF70LDM - 70mm, Concrete Slab - 150mm, $L_{n,w}$ 39dB

System Natural Frequency vs. Load

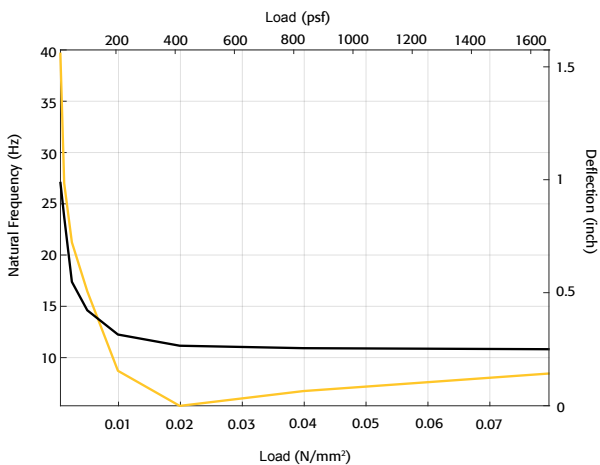

- GenieMat FF709R - Point Isolator
- GenieMat FF70LDM - Point Isolator

Deflection vs. Load

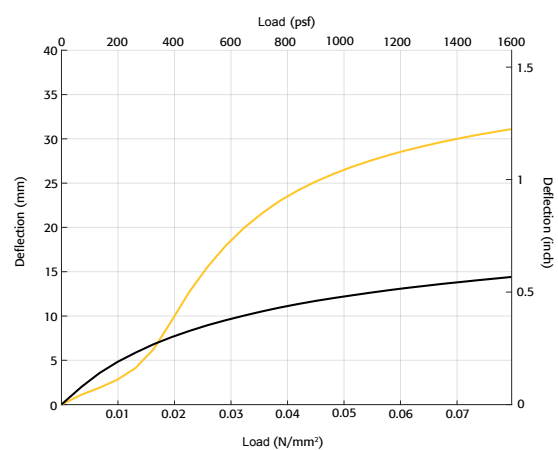

- GenieMat FF709R - Point Isolator
- GenieMat FF70LDM - Point Isolator

GENIEMAT® FF70 PANELISED SYSTEMS FOR BASKETBALL COURT ISOLATION

HOW TO MANAGE ACOUSTIC AND ATHLETIC PERFORMANCE

Basketball courts generate multiple sources of noise and vibration (e.g. ball impacts and running/jumping) and can have varying loads from retractable raked seating. The floors also demand stringent ball bounce-back performance (ASTM F2117).

Using a heavy/soft impact ball for laboratory testing and analysis using finite element analysis (FEA), **GenieMat FF70** and **GenieMat FF70LDM** have been proven to effectively mitigate noise and vibration in numerous college, university, and professional sports applications.

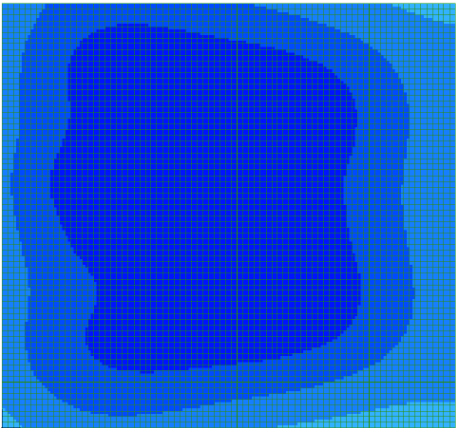

Bleacher Open

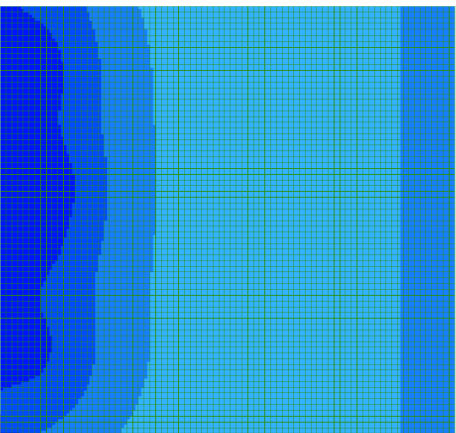

Bleacher Closed



FINITE ELEMENT ANALYSIS (FEA)

WHAT IS FEA?

Finite Element Analysis (FEA) is a system to break complex structures into very small parts (finite elements) that can then be more easily modeled and assessed. FEA is done in such a way as to tie all these elements together so the larger motion of the complete structure can be seen and assessed.

WHY IS FEA USEFUL WHEN DESIGNING YOUR FLOATING FLOOR?

While you may not realise it, the concrete in your floating floor can bend and crack. This can happen when there are very high point loads (large HVAC equipment) or if the floor is only loaded on one side (like a basketball court with a full crowd in the bleachers). Running a FEA can ensure that your floor will not crack. It can also be used to ensure the correct material is used under high load areas and how much the floor will deflect.

SITUATIONS IN WHICH FEA IS USEFUL:

- Non-uniform loading
- Predicting deflections to ensure smooth transitions
- Very high load equipment

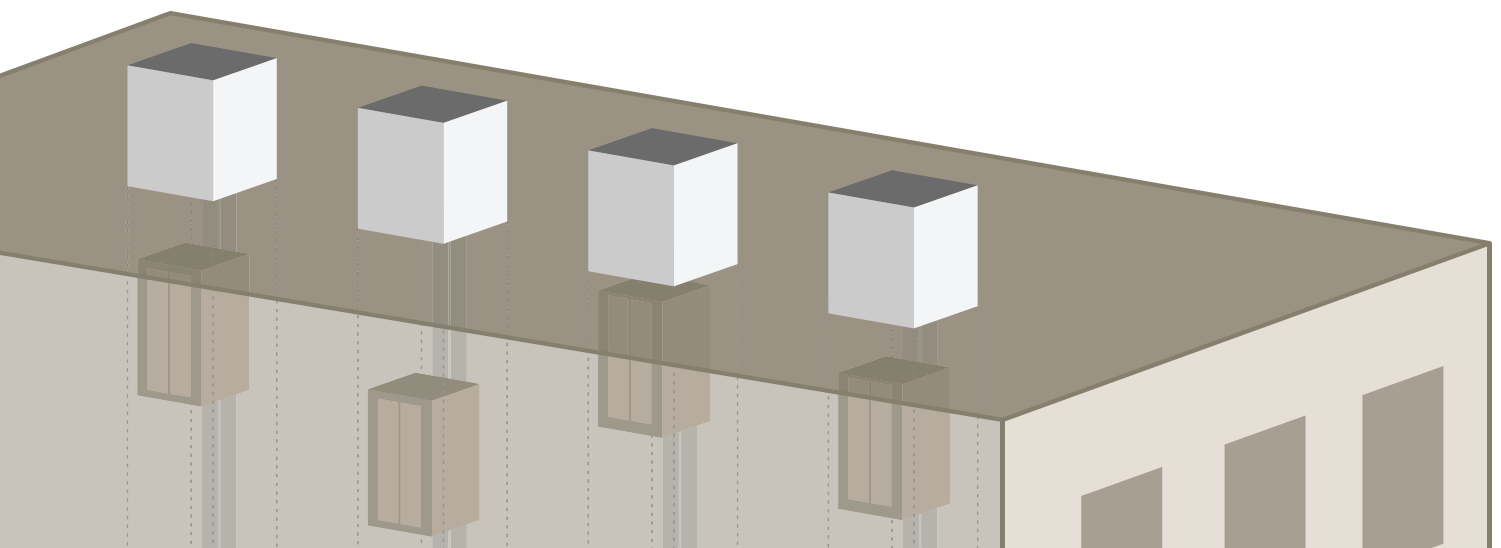

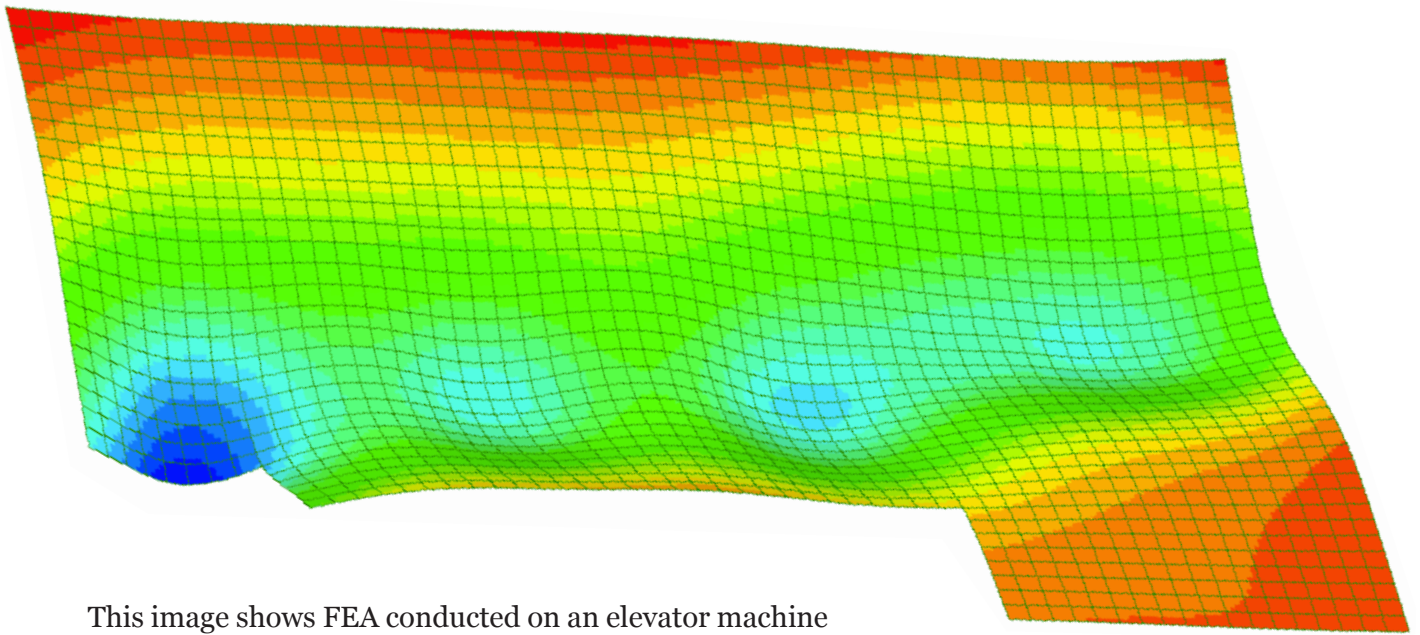

This image shows FEA conducted on an elevator machine room floating floor. The various colours show the varying loads and how much they will make the floor deflect.

Analysis requires only the structural drawings and a list of the dead and live loads.

This analysis allows for value engineering solutions to be assessed to find the most cost-effective solution

PRODUCT SPECIFICATIONS

PLAN VIEW	PRODUCT	THICKNESS	DIMENSION	WEIGHT	AREA
	GenieMat FF70	nom. 70 mm	Panel: nom. 0.6 m wide, 0.6 m long	5.8 kg	0.4 m ²
	GenieMat FF70LDM	nom. 70 mm	Panel: nom. 0.6 m wide, 0.6 m long	5.4 kg	0.4 m ²

TEST RESULTS

TEST REPORT	PRODUCT	FLOOR TOPPING	STRUCTURE	R _w	L _{n,w}
A1-008867.5	GenieMat FF70LDM	100 mm Concrete Slab	150 mm Concrete Slab	67	39
A1-008867.4	GenieMat FF70	100 mm Concrete Slab	150 mm Concrete Slab	68	45
E5600.08-113-11-R0	GenieMat FF70LDM	19 mm Plywood	150 mm Concrete Slab	63	46
E5600.01-113-11-R0	GenieMat FF70	19 mm Plywood	150 mm Concrete Slab	61	48

TEST RESULTS

TEST RESULTS					
TEST REPORT	PRODUCT	FLOOR TOPPING	STRUCTURE	R _w	L _{N,W}
B3498.1	None	None	150 mm Concrete Slab	53	78
F935-41976, F541-41780	GenieMat® FF17	100 mm Concrete Slab	150 mm Concrete Slab	70	49
F943-41992, F536-41779	GenieMat FF25	100 mm Concrete Slab	150 mm Concrete Slab	70	45
F920-41970, F539-41780	GenieMat FF50	100 mm Concrete Slab	150 mm Concrete Slab	72	43
F921-41970, F540-41780	GenieMat FF75	100 mm Concrete Slab	150 mm Concrete Slab	73	41
e8117.02	GenieMat FF70	100 mm Concrete Slab	150 mm Concrete Slab	64	46
F289-41701, F290-41701	GenieMat FF06	60 mm Screed	140 mm Concrete Slab	59	52
F292-41702, F291-41702	GenieMat FF10	60 mm Screed	140 mm Concrete Slab	59	51
F293-41702, F294-41702	GenieMat FF17	60 mm Screed	140 mm Concrete Slab	60	49
F296-41702, F295-41702	GenieMat FF25	60 mm Screed	140 mm Concrete Slab	61	47
F297-41702, F298-41702	GenieMat FF50	60 mm Screed	140 mm Concrete Slab	63	43
F6279.04	GenieMat FF17	45 mm Stone Pavers + 50 mm Adjustable Deck Supports	150 mm Concrete Slab	55	41
g2953.02	GenieMat FF25	(2) 12.5 mm Cement Board	150 mm Concrete Slab	55	51
g2953.04	GenieMat FF25	(2) 19 mm AdvanTech® Wood Subfloor	150 mm Concrete Slab	57	53
5014139, 7014190	GenieMat FF06	19 mm Gypsum Concrete	2x10 Wood Joist + GenieClip RST + 12.5 mm Plasterboard	59	58
5014142, 7014195	GenieMat FF06	Engineered Wood + 19 mm Screed + 19 mm Plywood	400 mm Open Web Truss + 12.5 mm Resilient Channel + 15 mm Plasterboard	56	57
g1707.11	GenieMat FF06	Vinyl + (2) 6 mm Cement Board + 19 mm OSB	450 mm Open Web Truss + 12.5 mm Resilient Channel + 15 mm Plasterboard	60	45
5014049, 7014060	None	None	Heavy Timber Floor	29	86
5014082, 7014109	None	100 mm Concrete Slab	Heavy Timber Floor	40	76
5014145, 7014200	GenieMat FF42	100 mm Concrete Slab	Heavy Timber Floor	54	59
7014194	GenieMat FF42	Vinyl + GenieMat RST05 + 50 mm Screed + 25 mm Cement Board	Heavy Timber Floor	53	58
F5500.08	GenieMat FF25	100 mm Concrete Slab	175 mm CLT	57	60
F6279.14	GenieMat FF25	Vinyl + GenieMat RST05 + 50 mm Screed	175 mm CLT	53	58
g1707.05	GenieMat FF23	100 mm Concrete Slab	175 mm CLT	56	58
F5500.10	GenieMat FF50	100 mm Concrete Slab	175 mm CLT	59	56

CONTACT US

For Your Project Specific Questions

UK +44 203 9846444 | **Asia Pacific** +65 8452 6865 | **Middle East** +971 4 813 5501

E. info@pliteq.co.uk

© Pliteq (UK) LTD. 2021.

08.21 ®™ Trademarks of Pliteq Inc. The information provided is accurate to the best of our knowledge at the time of issue. However, we reserve the right to make changes when necessary without further notification. Suggested application may need to be modified to conform with local building codes and conditions. We cannot accept responsibility for products that are not used, or installed, to our specifications. All listed dimensions are nominal.



www.pliteq.co.uk